

Quick-Connects

QC, QF, QV, QM and QTM Series



Contents

QC Series



D-27

QF Series



D-36

QV Series



D-41

QM Series

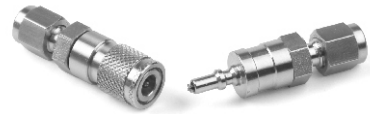

D-44

QTM Series



D-48

QC Series

Features

- ⦿ Working pressure up to: 3000 psig (207 bar)
- ⦿ Materials: Stainless steel or brass
- ⦿ Reliable, leak-tight O-ring seal for vacuum or pressure systems
- ⦿ Interchangeable with other key manufacturers' products
- ⦿ Single-end shutoff, double-end shutoff and full-flow model available
- ⦿ Push-to-connect coupling to enable quick and easy operation
- ⦿ Locking mechanism with large contact area to ensure reliable stem retainment
- ⦿ Stem protector, body protector and keyed options available

Single-end Shutoff (SESO)

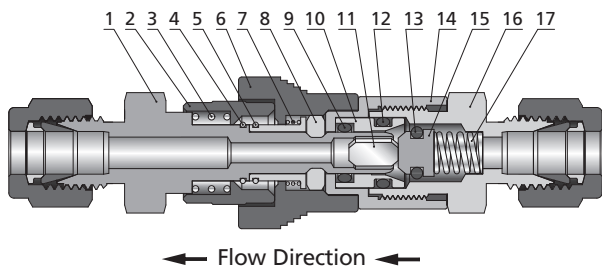

Double-end Shutoff (DESO) - Red Stem Sleeve

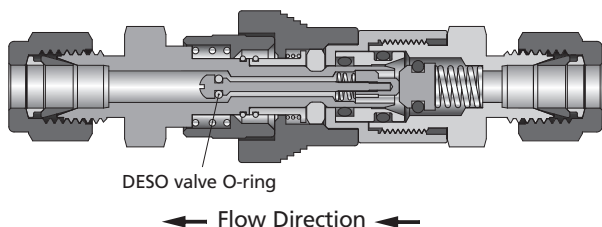

Full-flow Quick-Connects

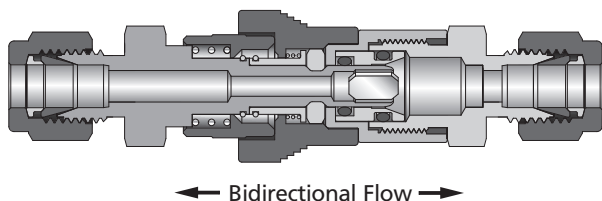

Standard Materials of Construction

Item	Component	Stainless Steel	Brass
		Material Grade/ASTM Specification	
1	Stem	316 SS/A479	Brass C36000/B16
2	DESO stem sleeve	PTFE-coated 316L SS/A479	PTFE-coated Brass C36000/B16
	SESO stem sleeve	316L SS/A479	Brass C36000/B16
3	Springs	316 SS/A313	
4	Snap rings	316 SS/A313	
5			
6	Body sleeve	316L SS/A479	Brass C36000/B16
7	Springs	316 SS/A313	
8	Locking dogs	Xylan®-coated 316 SS powdered metal	
9	O-rings	Fluorocarbon FKM	Buna N
10	Sliding sleeve	316 SS/A479	Brass C36000/B16
11	SESO stem insert	316 SS/A240	Brass C26000/B36
12	O-rings	Fluorocarbon FKM	Buna N
13	O-rings	Fluorocarbon FKM	Buna N
14	Housing	316L SS/A479	Brass C36000/B16
15	Plug	316 SS/A479	Brass C36000/B16
16	Body	316 SS/A479	Brass C36000/B16
17	Springs	316 SS/A313	
18	Lubricants	Silicone-based	

Insertion Depth

Series	Insertion Depth	
	SESO	DESO
	in. (mm)	in. (mm)
QC4	1.09 (27.7)	1.15 (29.2)
QC6	1.18 (30.0)	1.30 (33.0)
QC8	1.48 (37.6)	1.68 (42.7)

In order to measure overall length in the coupled position, the insertion depth should be deducted from any overall stem and body combination length.

Spillage and Air Inclusion

Spillage - the amount of system fluid that escapes when a quick-connect is uncoupled (DESO only)

Air Inclusion - the amount of air trapped between the body and stem that enters the system when a quick-connect is coupled (DESO only)

Series	Spillage, cm ³	Air Inclusion, cm ³
QC4	0.3	0.3
QC6	1.0	1.0
QC8	3.0	3.0

Pressure-Temperature Ratings

Pressure rating restrictions apply when coupling and uncoupling (DESO only). Refer to the tables below for specific data.

QC4 Series

Material	316 SS			Brass
O-Ring Material	Fluorocarbon FKM	Ethylene propylene	Perfluoro-carbon FFKM	Buna N
Temperature °F (°C)	Pressure Rating, psig (bar)			
Coupled				
-50 (-45)	—	3000 (206)	—	—
0 (-17)	3000 (206)	3000 (206)	3000 (206)	2000 (137)
10 (-12)	3000 (206)	3000 (206)	3000 (206)	2000 (137)
60 (15)	3000 (206)	3000 (206)	3000 (206)	2000 (137)
100 (37)	3000 (206)	3000 (206)	3000 (206)	2000 (137)
150 (65)	2750 (189)	2750 (189)	2750 (189)	1300 (895)
200 (93)	2300 (158)	2300 (158)	2300 (158)	700 (48)
250 (121)	1850 (127)	1850 (127)	1850 (127)	300 (20.6)
300 (148)	1400 (96.4)	1400 (96.4)	1400 (96.4)	—
350 (176)	950 (65.4)	—	950 (65.4)	—
400 (204)	500 (34.4)	—	500 (34.4)	—
500 (260)	—	—	150 (10.3)	—
Uncoupled and When Coupling and Uncoupling				
70 (20)	250 (17.2)			

QC6 Series

Material	316 SS			Brass
O-Ring Material	Fluorocarbon FKM	Ethylene propylene	Perfluoro-carbon FFKM	Buna N
Temperature °F (°C)	Pressure Rating, psig (bar)			
Coupled				
-50 (-45)	—	1500 (103)	—	—
0 (-17)	1500 (103)	1500 (103)	1500 (103)	1000 (68.9)
10 (-12)	1500 (103)	1500 (103)	1500 (103)	1000 (68.9)
60 (15)	1500 (103)	1500 (103)	1500 (103)	1000 (68.9)
100 (37)	1500 (103)	1500 (103)	1500 (103)	1000 (68.9)
150 (65)	1350 (93.0)	1350 (93.0)	1350 (93.0)	700 (48.2)
200 (93)	1150 (79.2)	1150 (79.2)	1150 (79.2)	450 (31.0)
250 (121)	970 (66.8)	970 (66.8)	970 (66.8)	300 (20.6)
300 (148)	750 (51.6)	750 (51.6)	750 (51.6)	—
350 (176)	580 (39.9)	—	580 (39.9)	—
400 (204)	400 (27.5)	—	400 (27.5)	—
500 (260)	—	—	150 (10.3)	—
Uncoupled and When Coupling and Uncoupling				
70 (20)	250 (17.2)			

QC8 Series

Material	316 SS			Brass
O-Ring Material	Fluorocarbon FKM	Ethylene propylene	Perfluoro-carbon FFKM	Buna N
Temperature °F (°C)	Pressure Rating, psig (bar)			
Coupled				
-50 (-45)	—	750 (51.6)	—	—
0 (-17)	750 (51.6)	750 (51.6)	750 (51.6)	500 (34.4)
10 (-12)	750 (51.6)	750 (51.6)	750 (51.6)	500 (34.4)
60 (15)	750 (51.6)	750 (51.6)	750 (51.6)	500 (34.4)
100 (37)	750 (51.6)	750 (51.6)	750 (51.6)	500 (34.4)
150 (65)	680 (46.8)	680 (46.8)	680 (46.8)	400 (27.5)
200 (93)	600 (41.3)	600 (41.3)	600 (41.3)	350 (24.1)
250 (121)	520 (35.8)	520 (35.8)	520 (35.8)	300 (20.6)
300 (148)	440 (30.3)	440 (30.3)	440 (30.3)	—
350 (176)	360 (24.8)	—	360 (24.8)	—
400 (204)	300 (20.6)	—	300 (20.6)	—
500 (260)	—	—	150 (10.3)	—
Uncoupled and When Coupling and Uncoupling				
70 (20)	250 (17.2)			

Dimensions

SESO Stems

Tube Fitting

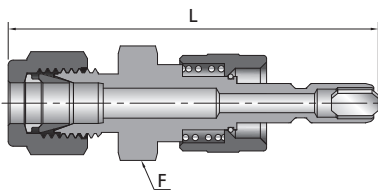

Male NPT

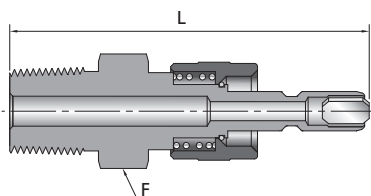

Female NPT

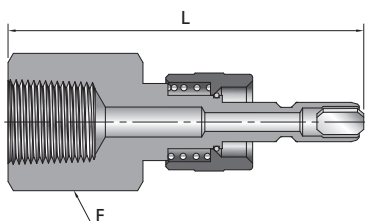

Male BSPT

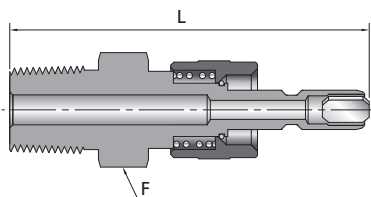

Female BSPT

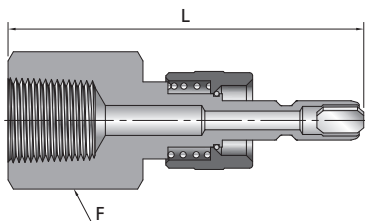

Male JIC(AN) 37° Flare

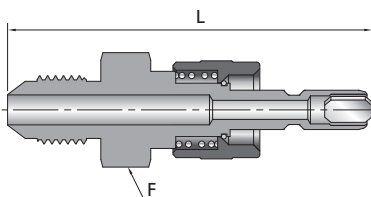

Fitting Size in.	Basic Ordering Number	Flow Coefficient (Cv)	Dimensions	
			F in.	L in. (mm)
1/8	-QC4-FL2-S	0.08	5/8	2.32 (58.9)
1/4	-QC4-FL4-S	0.3	5/8	2.36 (59.9)
3/8	-QC6-FL6-S	1.0	3/4	2.52 (64.0)
1/2	-QC8-FL8-S	2.4	15/16	2.96 (75.2)
mm			mm	mm (in.)
6	-QC4-ML6-S	0.3	16	59.9 (2.36)
10	-QC6-ML10-S	1.0	19	67.3 (2.65)
12	-QC8-ML12-S	2.4	24	75.2 (2.96)

NPT Size in.	Basic Ordering Number	Flow Coefficient (Cv)	Dimensions	
			F in.	L in. (mm)
1/8	-QC4-NS2-S	0.3	5/8	2.07 (52.6)
1/4	-QC4-NS4-S	0.3	5/8	2.22 (56.4)
1/4	-QC6-NS4-S	0.8	3/4	2.32 (58.9)
3/8	-QC6-NS6-S	0.8	3/4	2.35 (59.7)
1/2	-QC8-NS8-S	2.0	15/16	2.84 (72.1)

NPT Size in.	Basic Ordering Number	Flow Coefficient (Cv)	Dimensions	
			F in.	L in. (mm)
1/8	-QC4-FNS2-S	0.3	5/8	2.01 (51.1)
1/4	-QC4-FNS4-S	0.3	3/4	2.26 (57.4)
1/4	-QC6-FNS4-S	0.8	3/4	2.35 (59.7)
3/8	-QC6-FNS6-S	0.8	7/8	2.35 (59.7)
1/2	-QC8-FNS8-S	2.0	1 1/16	2.82 (71.6)

BSPT Size in.	Basic Ordering Number	Flow Coefficient (Cv)	Dimensions	
			F in.	L in. (mm)
1/8	-QC4-RT2-S	0.3	5/8	2.07 (52.6)
1/4	-QC4-RT4-S	0.3	5/8	2.22 (56.4)
1/4	-QC6-RT4-S	0.8	3/4	2.32 (58.9)
3/8	-QC6-RT6-S	0.8	3/4	2.35 (59.7)
1/2	-QC8-RT8-S	2.0	15/16	2.84 (72.1)

BSPT Size in.	Basic Ordering Number	Flow Coefficient (Cv)	Dimensions	
			F in.	L in. (mm)
1/8	-QC4-FRT2-S	0.3	5/8	2.01 (51.1)
1/4	-QC4-FRT4-S	0.3	3/4	2.26 (57.4)
1/4	-QC6-FRT4-S	0.8	3/4	2.35 (59.7)
3/8	-QC6-FRT6-S	0.8	7/8	2.35 (59.7)
1/2	-QC8-FRT8-S	2.0	1 1/16	2.82 (71.6)

Fitting Size in.	Basic Ordering Number	Flow Coefficient (Cv)	Dimensions	
			F in.	L in. (mm)
1/4	-QC4-AN4-S	0.2	5/8	2.23 (56.6)
3/8	-QC6-AN6-S	1.0	3/4	2.35 (59.7)
1/2	-QC8-AN8-S	2.4	15/16	2.79 (70.9)

D-30 Quick-Connects

Hose Connector

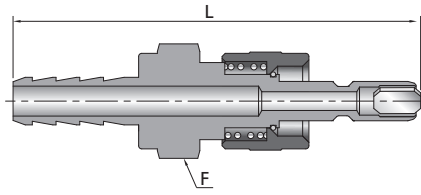

Hose Size in.	Basic Ordering Number	Flow Coefficient (Cv)	Dimensions	
			F in.	L in. (mm)
1/4	-QC4-HC4-S	0.2	5/8	2.47 (62.7)
3/8	-QC6-HC6-S	1.0	3/4	2.66 (67.6)
1/2	-QC8-HC8-S	2.4	15/16	3.07 (78.0)

Bulkhead Tube Fitting

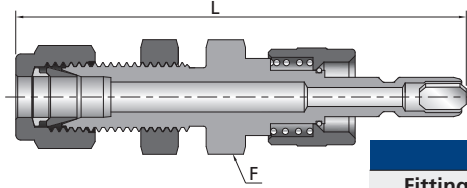

Fitting Size in.	Basic Ordering Number	Flow Coefficient (Cv)	Dimensions		Min. Panel Orifice in. (mm)	Max. Panel Thickness in. (mm)
			F in.	L in. (mm)		
1/4	-QC4-BFL4-S	0.3	5/8	2.74 (69.6)	0.47 (11.9)	0.25 (6.4)
3/8	-QC6-BFL6-S	1.0	3/4	2.92 (74.2)	0.60 (15.2)	0.27 (6.9)
1/2	-QC8-BFL8-S	2.4	15/16	3.43 (87.1)	0.78 (19.8)	0.26 (6.6)
mm	—	—	mm	mm (in.)	mm (in.)	mm (in.)
6	-QC4-BML6-S	0.3	16	69.6 (2.74)	11.7 (0.46)	6.4 (0.25)
10	-QC6-BML10-S	1.0	22	77.7 (3.06)	16.8 (0.66)	6.9 (0.27)
12	-QC8-BML12-S	2.4	24	87.1 (3.43)	19.6 (0.77)	6.6 (0.26)

DESO Stems

Tube Fitting

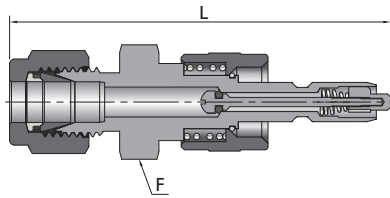

Fitting Size in.	Basic Ordering Number	Flow Coefficient (Cv)	Dimensions	
			F in.	L in. (mm)
1/8	-QC4-FL2-D	0.08	5/8	2.77 (70.4)
1/4	-QC4-FL4-D	0.2	5/8	2.42 (61.5)
3/8	-QC6-FL6-D	0.5	3/4	2.64 (67.1)
1/2	-QC8-FL8-D	1.5	15/16	3.16 (80.3)
mm	—	—	mm	mm (in.)
6	-QC4-ML6-D	0.2	16	61.5 (2.42)
10	-QC6-ML10-D	0.5	19	70.4 (2.77)
12	-QC8-ML12-D	1.5	24	80.3 (3.16)

Male NPT

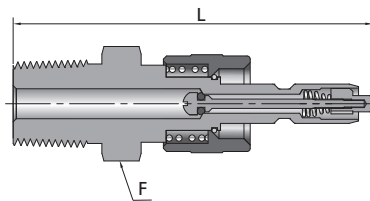

NPT Size in.	Basic Ordering Number	Flow Coefficient (Cv)	Dimensions	
			F in.	L in. (mm)
1/8	-QC4-NS2-D	0.2	5/8	2.13 (54.1)
1/4	-QC4-NS4-D	0.2	5/8	2.28 (57.8)
1/4	-QC6-NS4-D	0.5	3/4	2.44 (61.9)
3/8	-QC6-NS6-D	0.5	3/4	2.47 (62.7)
1/2	-QC8-NS8-D	1.3	15/16	3.04 (77.2)

Female NPT

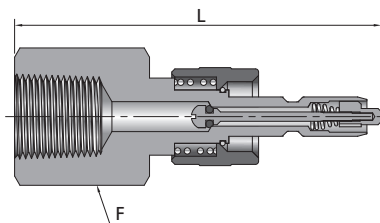

NPT Size in.	Basic Ordering Number	Flow Coefficient (Cv)	Dimensions	
			F in.	L in. (mm)
1/8	-QC4-FNS2-D	0.2	5/8	2.07 (52.6)
1/4	-QC4-FNS4-D	0.2	3/4	2.32 (58.9)
1/4	-QC6-FNS4-D	0.5	3/4	2.47 (62.7)
3/8	-QC6-FNS6-D	0.5	7/8	2.47 (62.7)
1/2	-QC8-FNS8-D	1.3	1 1/16	3.04 (77.2)

Male BSPT

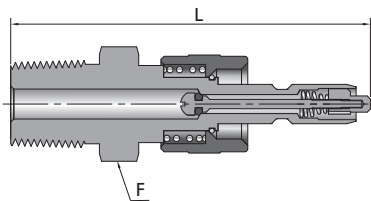

BSPT Size in.	Basic Ordering Number	Flow Coefficient (Cv)	Dimensions	
			F	L
			in.	in. (mm)
1/8	-QC4-RT2-D	0.2	5/8	2.13 (54.1)
1/4	-QC4-RT4-D	0.2	5/8	2.28 (57.8)
1/4	-QC6-RT4-D	0.5	3/4	2.44 (61.9)
3/8	-QC6-RT6-D	0.5	3/4	2.47 (62.7)
1/2	-QC8-RT8-D	1.3	15/16	3.04 (77.2)

Female BSPT

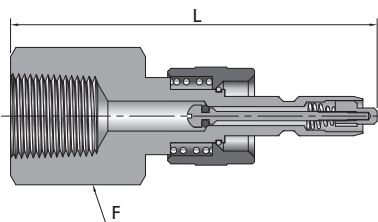

BSPT Size in.	Basic Ordering Number	Flow Coefficient (Cv)	Dimensions	
			F	L
			in.	in. (mm)
1/8	-QC4-FRT2-D	0.2	5/8	2.07 (52.6)
1/4	-QC4-FRT4-D	0.2	3/4	2.32 (58.9)
1/4	-QC6-FRT4-D	0.5	3/4	2.47 (62.7)
3/8	-QC6-FRT6-D	0.5	7/8	2.47 (62.7)
1/2	-QC8-FRT8-D	1.3	1 1/16	3.04 (77.2)

Male JIC(AN) 37° Flare

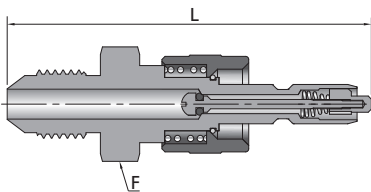

Fitting Size in.	Basic Ordering Number	Flow Coefficient (Cv)	Dimensions	
			F	L
			in.	in. (mm)
1/4	-QC4-AN4-D	0.2	5/8	2.29 (58.2)
3/8	-QC6-AN6-D	0.5	3/4	2.47 (62.7)
1/2	-QC8-AN8-D	1.5	15/16	2.99 (75.9)

Hose Connector

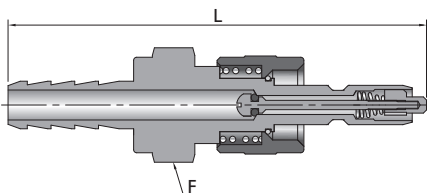

Hose Size in.	Basic Ordering Number	Flow Coefficient (Cv)	Dimensions	
			F	L
			in.	in. (mm)
1/4	-QC4-HC4-D	0.2	5/8	2.53 (64.3)
3/8	-QC6-HC6-D	0.5	3/4	2.78 (70.6)
1/2	-QC8-HC8-D	1.5	15/16	3.27 (83.1)

Bulkhead Tube Fitting

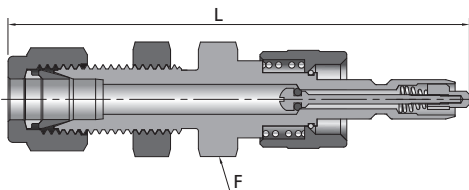

Fitting Size in.	Basic Ordering Number	Flow Coefficient (Cv)	Dimensions		Min. Panel Orifice in. (mm)	Max. Panel Thickness in. (mm)
			F	L		
			in.	in. (mm)		
1/4	-QC4-BFL4-D	0.2	5/8	2.80 (71.1)	0.47 (11.9)	0.25 (6.4)
3/8	-QC6-BFL6-D	0.5	3/4	3.07 (78.0)	0.60 (15.2)	0.27 (6.9)
1/2	-QC8-BFL8-D	1.5	15/16	3.63 (92.2)	0.78 (19.8)	0.26 (6.6)
mm			mm	mm (in.)	mm (in.)	mm (in.)
6	-QC4-BML6-D	0.2	16	71.1 (2.80)	11.7 (0.46)	6.4 (0.25)
10	-QC6-BML10-D	0.5	22	78.7 (3.10)	16.8 (0.66)	6.9 (0.27)
12	-QC8-BML12-D	1.5	24	92.2 (3.63)	19.6 (0.77)	6.6 (0.26)

Hoses Quick-Connects

Bodies

Tube Fitting

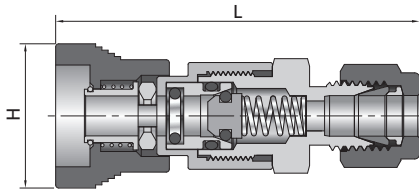

Male NPT

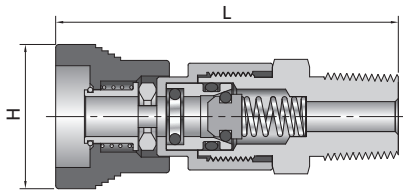

Female NPT

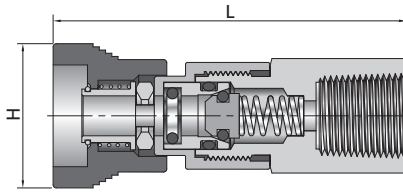

Male BSPT

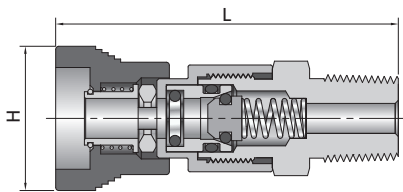

Female BSPT

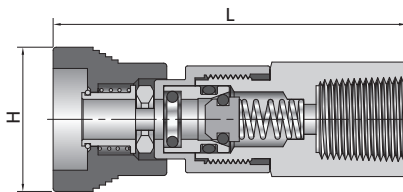

Male JIC (AN) 37° Flare

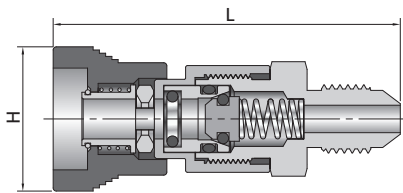

Fitting Size in.	Basic Ordering Number	Dimensions	
		H in.	L in. (mm)
1/8	-QC4-FL2-B	0.91 (23.1)	2.26 (57.4)
1/4	-QC4-FL4-B	0.91 (23.1)	2.30 (58.4)
3/8	-QC6-FL6-B	1.03 (26.2)	2.58 (65.5)
1/2	-QC8-FL8-B	1.21 (30.7)	3.09 (78.5)
mm		mm (in.)	mm (in.)
6	-QC4-ML6-B	23.1 (0.91)	58.4 (2.30)
10	-QC6-ML10-B	26.2 (1.03)	68.1 (2.68)
12	-QC8-ML12-B	30.7 (1.21)	78.5 (3.09)

NPT Size in.	Basic Ordering Number	Dimensions	
		H in.	L in. (mm)
1/8	-QC4-NS2-B	0.91 (23.1)	2.01 (51.1)
1/4	-QC4-NS4-B	0.91 (23.1)	2.16 (54.9)
1/4	-QC6-NS4-B	1.03 (26.2)	2.38 (60.5)
3/8	-QC6-NS6-B	1.03 (26.2)	2.38 (60.5)
1/2	-QC8-NS8-B	1.21 (30.7)	2.97 (75.4)

NPT Size in.	Basic Ordering Number	Dimensions	
		H in.	L in. (mm)
1/8	-QC4-FNS2-B	0.91 (23.1)	2.16 (54.9)
1/4	-QC4-FNS4-B	0.91 (23.1)	2.42 (61.5)
1/4	-QC6-FNS4-B	1.03 (26.2)	2.54 (64.5)
3/8	-QC6-FNS6-B	1.03 (26.2)	2.57 (65.3)
1/2	-QC8-FNS8-B	1.21 (30.7)	3.22 (81.8)

BSPT Size in.	Basic Ordering Number	Dimensions	
		H in.	L in. (mm)
1/8	-QC4-RT2-B	0.91 (23.1)	2.01 (51.1)
1/4	-QC4-RT4-B	0.91 (23.1)	2.16 (54.9)
1/4	-QC6-RT4-B	1.03 (26.2)	2.38 (60.5)
3/8	-QC6-RT6-B	1.03 (26.2)	2.38 (60.5)
1/2	-QC8-RT8-B	1.21 (30.7)	2.97 (75.4)

BSPT Size in.	Basic Ordering Number	Dimensions	
		H in.	L in. (mm)
1/8	-QC4-FRT2-B	0.91 (23.1)	2.16 (54.9)
1/4	-QC4-FRT4-B	0.91 (23.1)	2.42 (61.5)
1/4	-QC6-FRT4-B	1.03 (26.2)	2.54 (64.5)
3/8	-QC6-FRT6-B	1.03 (26.2)	2.57 (65.3)
1/2	-QC8-FRT8-B	1.21 (30.7)	3.22 (81.8)

Fitting Size in.	Basic Ordering Number	Dimensions	
		H in.	L in. (mm)
1/4	-QC4-AN4-B	0.91 (23.1)	2.17 (55.1)
3/8	-QC6-AN6-B	1.03 (26.2)	2.41 (61.2)
1/2	-QC8-AN8-B	1.21 (30.7)	2.92 (74.2)

Hose Connector

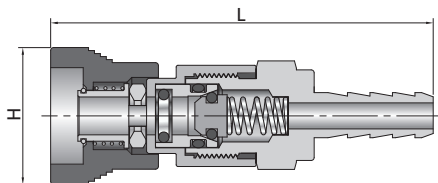

Hose Size in.	Basic Ordering Number	Dimensions	
		H in.	L in. (mm)
1/4	-QC4-HC4-B	0.91 (23.1)	2.41 (61.2)
3/8	-QC6-HC6-B	1.03 (26.2)	2.72 (69.1)
1/2	-QC8-HC8-B	1.21 (30.7)	3.20 (81.3)

Bulkhead Tube Fitting

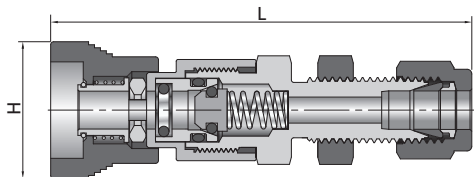

Fitting Size in.	Basic Ordering Number	Dimensions		Min. Panel Orifice in. (mm)	Max. Panel Thickness in. (mm)
		H in.	L in. (mm)		
1/4	-QC4-BFL4-B	0.91 (23.1)	2.67 (67.8)	0.47 (11.9)	0.25 (6.4)
3/8	-QC6-BFL6-B	1.03 (26.2)	2.98 (75.7)	0.60 (15.2)	0.27 (6.9)
1/2	-QC8-BFL8-B	1.21 (30.7)	3.56 (90.4)	0.78 (19.8)	0.26 (6.6)
mm		mm (in.)	mm (in.)	mm (in.)	mm (in.)
6	-QC4-BML6-B	23.1 (0.91)	67.8 (2.67)	11.7 (0.46)	6.4 (0.25)
10	-QC6-BML10-B	26.2 (1.03)	75.9 (2.99)	16.8 (0.66)	6.9 (0.27)
12	-QC8-BML12-B	30.7 (1.21)	90.4 (3.56)	19.6 (0.77)	6.6 (0.26)

Full-flow Bodies

Tube Fitting

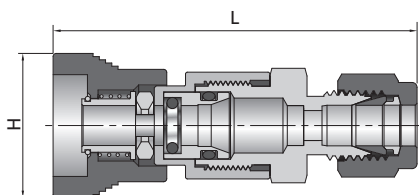

Fitting Size in.	Basic Ordering Number	Dimensions	
		H in.	L in. (mm)
1/8	-QC4-FL2-F	0.91 (23.1)	2.26 (57.4)
1/4	-QC4-FL4-F	0.91 (23.1)	2.30 (58.4)
3/8	-QC6-FL6-F	1.03 (26.2)	2.58 (65.5)
1/2	-QC8-FL8-F	1.21 (30.7)	3.09 (78.5)
mm		mm (in.)	mm (in.)
6	-QC4-ML6-F	23.1 (0.91)	58.4 (2.30)
10	-QC6-ML10-F	26.2 (1.03)	68.1 (2.68)
12	-QC8-ML12-F	30.7 (1.21)	78.5 (3.09)

Male NPT

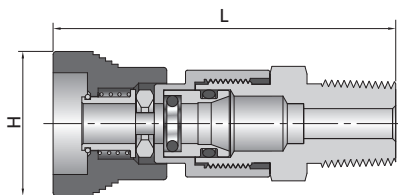

NPT Size in.	Basic Ordering Number	Dimensions	
		H in.	L in. (mm)
1/8	-QC4-NS2-F	0.91 (23.1)	2.01 (51.1)
1/4	-QC4-NS4-F	0.91 (23.1)	2.16 (54.9)
1/4	-QC6-NS4-F	1.03 (26.2)	2.38 (60.5)
3/8	-QC6-NS6-F	1.03 (26.2)	2.38 (60.5)
1/2	-QC8-NS8-F	1.21 (30.7)	2.97 (75.4)

Female NPT

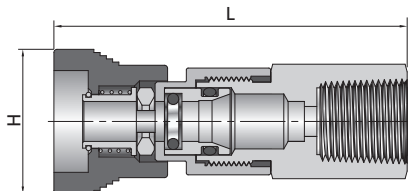

NPT Size in.	Basic Ordering Number	Dimensions	
		H in.	L in. (mm)
1/8	-QC4-FNS2-F	0.91 (23.1)	2.16 (54.9)
1/4	-QC4-FNS4-F	0.91 (23.1)	2.42 (61.5)
1/4	-QC6-FNS4-F	1.03 (26.2)	2.54 (65.4)
3/8	-QC6-FNS6-F	1.03 (26.2)	2.57 (65.3)
1/2	-QC8-FNS8-F	1.21 (30.7)	3.22 (81.8)

Male BSPT

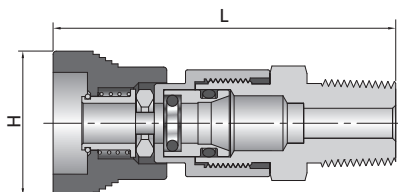

BSPT Size in.	Basic Ordering Number	Dimensions	
		H in.	L in. (mm)
1/8	-QC4-RT2-F	0.91 (23.1)	2.01 (51.1)
1/4	-QC4-RT4-F	0.91 (23.1)	2.16 (54.9)
1/4	-QC6-RT4-F	1.03 (26.2)	2.38 (60.5)
3/8	-QC6-RT6-F	1.03 (26.2)	2.38 (60.5)
1/2	-QC8-RT8-F	1.21 (30.7)	2.97 (75.4)

D-34 Quick-Connects

Female BSPT

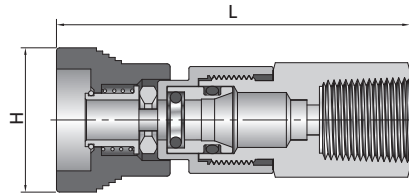

BSPT Size in.	Basic Ordering Number	Dimensions	
		H in.	L in. (mm)
1/8	-QC4-FRT2-F	0.91 (23.1)	2.16 (54.9)
1/4	-QC4-FRT4-F	0.91 (23.1)	2.42 (61.5)
1/4	-QC6-FRT4-F	1.03 (26.2)	2.54 (64.5)
3/8	-QC6-FRT6-F	1.03 (26.2)	2.57 (65.3)
1/2	-QC8-FRT8-F	1.21 (30.7)	3.22 (81.8)

Male JIC (AN) 37° Flare

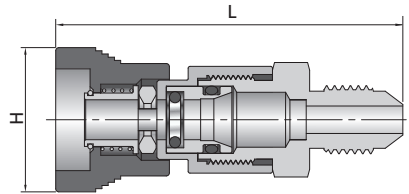

Fitting Size in.	Basic Ordering Number	Dimensions	
		H in.	L in. (mm)
1/4	-QC4-AN4-F	0.91 (23.1)	2.17 (55.1)
3/8	-QC6-AN6-F	1.03 (26.2)	2.41 (61.2)
1/2	-QC8-AN8-F	1.21 (30.7)	2.92 (74.2)

Hose Connector

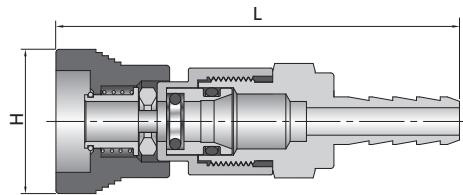

Hose Size in.	Basic Ordering Number	Dimensions	
		H in.	L in. (mm)
1/4	-QC4-HC4-F	0.91 (23.1)	2.41 (61.2)
3/8	-QC6-HC6-F	1.03 (26.2)	2.72 (69.1)
1/2	-QC8-HC8-F	1.21 (30.7)	3.20 (81.3)

Bulkhead Tube Fitting

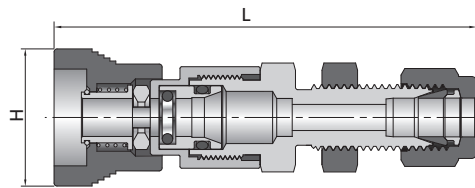

Fitting Size in.	Basic Ordering Number	Dimensions		Min. Panel Orifice in. (mm)	Max. Panel Thickness in. (mm)
		H in.	L in. (mm)		
1/4	-QC4-BFL4-F	0.91 (23.1)	2.67 (67.8)	0.47 (11.9)	0.25 (6.4)
3/8	-QC6-BFL6-F	1.03 (26.2)	2.98 (75.7)	0.60 (15.2)	0.27 (6.9)
1/2	-QC8-BFL8-F	1.21 (30.7)	3.56 (90.4)	0.78 (19.8)	0.26 (6.6)
mm	—	mm (in.)	mm (in.)	mm (in.)	mm (in.)
6	-QC4-BML6-F	23.1 (0.91)	67.8 (2.67)	11.7 (0.46)	6.4 (0.25)
10	-QC6-BML10-F	26.2 (1.03)	75.9 (2.99)	16.8 (0.66)	6.9 (0.27)
12	-QC8-BML12-F	30.7 (1.21)	90.4 (3.56)	19.6 (0.77)	6.6 (0.26)

Options, QC Series

Keyed QC Series

FITOK keyed quick-connects provide a reliable mechanical lockout system to prevent accidental intermixing of different lines in multifluid or multipressure systems.

QC Series Key Numbers and Sleeve Outside Diameters

Key Number	Color	QC4		QC6		QC8	
		Body Sleeve	Stem Sleeve	Body Sleeve	Stem Sleeve	Body Sleeve	Stem Sleeve
		in. (mm)	in. (mm)	in. (mm)	in. (mm)	in. (mm)	in. (mm)
K1	Black	0.96 (24.4)	0.82 (20.8)	1.13 (28.7)	0.99 (25.1)	1.26 (32.0)	1.10 (27.9)
K2	Orange	0.99 (25.1)	0.85 (21.6)	1.16 (29.5)	1.02 (25.9)	1.29 (32.8)	1.14 (29.0)
K3	Green	1.02 (25.9)	0.88 (22.4)	1.19 (30.2)	1.05 (26.7)	1.32 (33.5)	1.17 (29.7)
K4	Yellow	1.05 (26.7)	0.91 (23.1)	1.22 (31.0)	1.08 (27.4)	1.35 (34.3)	1.20 (30.5)
K5	Blue	1.08 (27.4)	0.94 (23.9)	1.24 (31.5)	1.11 (28.2)	1.38 (35.1)	1.23 (31.2)
K6	White	1.11 (28.2)	0.97 (24.6)	1.28 (32.5)	1.14 (29.0)	1.41 (35.8)	1.26 (32.0)
K7	Purple	1.14 (29.0)	1.00 (25.4)	1.31 (33.3)	1.17 (29.7)	1.44 (36.6)	1.29 (32.8)
K8	Brown	1.17 (29.7)	1.03 (26.2)	1.34 (34.0)	1.20 (30.5)	1.47 (37.3)	1.32 (33.5)

Stem and Body Protector

Stem and body protector can prevent the stem and the body from being damaged and polluted when uncoupling.

Stem Protector

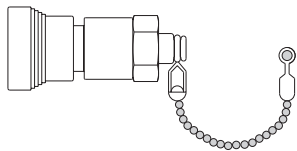

Series	Basic Ordering Number
QC4	-QC4-SP
QC6	-QC6-SP
QC8	-QC8-SP

Body Protector

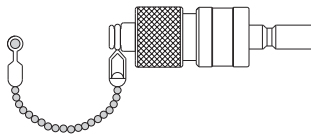

Series	Basic Ordering Number
QC4	-QC4-BP
QC6	-QC6-BP
QC8	-QC8-BP

- Ordering number description of the protector: material designator (SS for stainless steel or B for brass) + basic ordering number.
Example: **SS-QC4-BP**
- Ordering number description of the keyed protector: material designator (SS for stainless steel or B for brass) + basic ordering number+key number.
Example: **SS-QC4-BP-K2**
- The protector is not a pressure sustaining device. To order pressure sustaining device, please contact FITOK Group or our authorized distributors.

Ordering Number Description

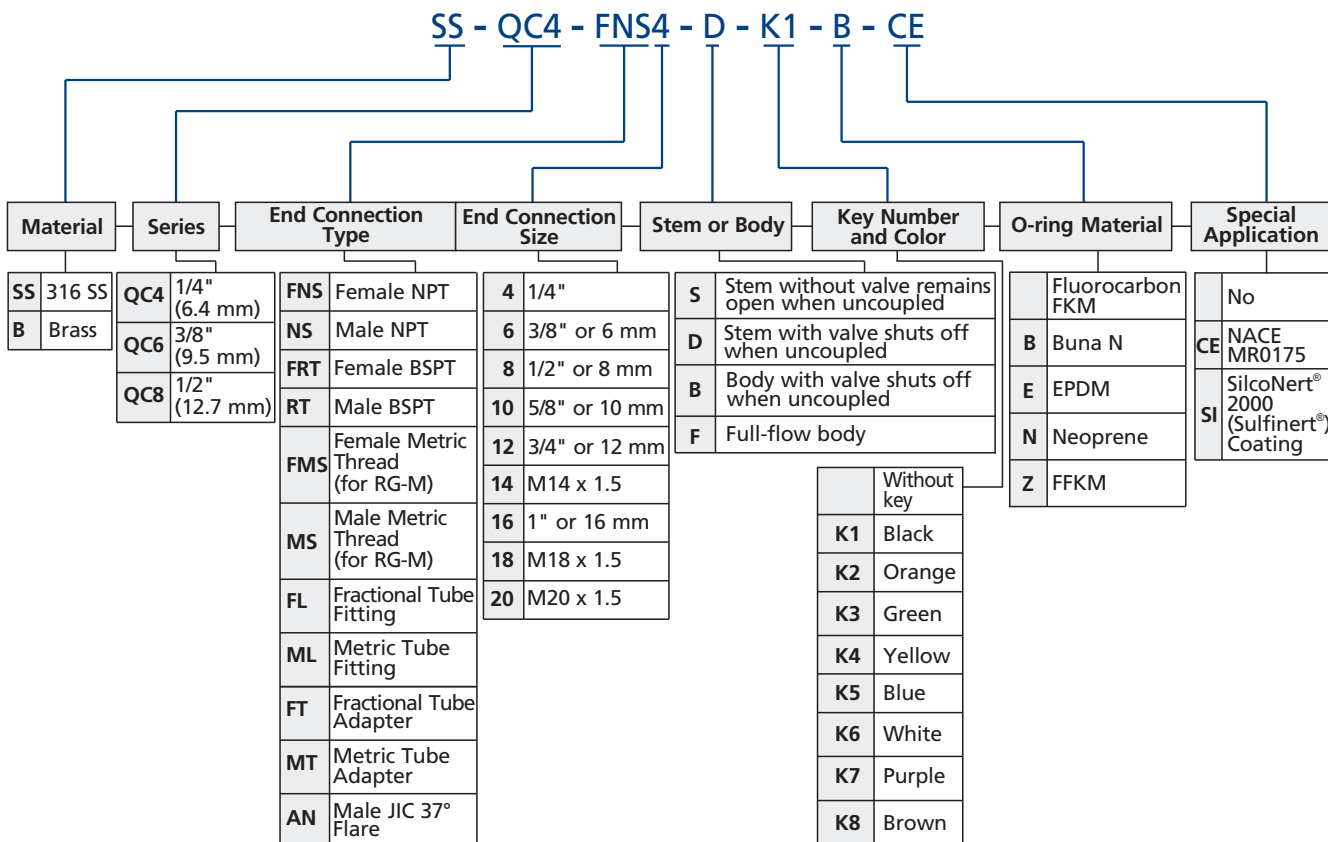

- Note: 1. "Ordering Number Description" is a reference to understand the combination rules of FITOK product part number. Not all combinations are available.
 2. Dimensions are for reference only and are subject to change.
 3. Special Application
 Wetted metal components SilcoNert® 2000 (Sulfinert®) coated.

QF Series

Features

- ⦿ Working pressure up to: 6000 psig (414 bar)
- ⦿ Materials: stainless steel or brass
- ⦿ Full flow
- ⦿ Quick, easy operation
- ⦿ Smooth and open bores without valve on either end to minimize pressure drop and allow easy cleaning

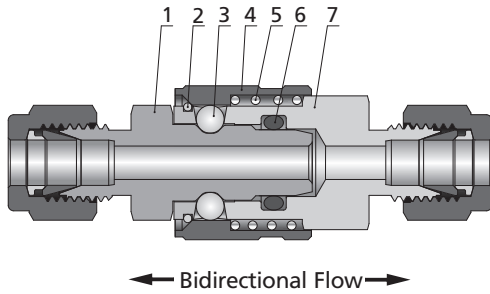

Standard Materials of Construction

Item	Component	Stainless Steel	Brass
		Material Grade/ASTM Specification	
1	Stem	316 SS/A479	Brass C36000/B16
2	Snap rings	316 SS/A313	
3	Locking balls	440C/A276	
4	Sliding sleeve	316L SS/A479	C36000/B16
5	Springs	316 SS/A313	
6	O-rings	Fluorocarbon FKM	Buna N
7	Body	316 SS/A479	Brass C36000/B16
8	Lubricants	Silicone-based	

Insertion Depth

Series	Insertion Depth
	in. (mm)
QF4	0.78 (19.8)
QF8	0.81 (20.6)
QF12	0.90 (22.9)
QF16	0.94 (23.9)

In order to measure overall length in the coupled position, insertion depth should be deducted from any overall stem and body combination length.

Pressure-Temperature Ratings

1. Pressure ratings may be limited by end connections.
2. Quick-Connects in compliance with NACE MR0175 are subject to a lower pressure rating.
For more information, please contact FITOK Group or our authorized distributors.
3. Do not uncouple under pressure.

QF4 Series and QF8 Series

Material	316 SS			Brass	
	O-Ring Material	Fluorocarbon FKM	Ethylene propylene	Perfluorocarbon FFKM	Buna N
Series	QF4 and QF8			QF4	QF8
Temperature °F (°C)	Pressure Rating, psig (bar)				
Coupled					
-50 (-45)	—	6000 (413)	—	—	—
0 (-17)	6000 (413)	6000 (413)	6000 (413)	4000 (275)	3000 (206)
10 (-12)	6000 (413)	6000 (413)	6000 (413)	4000 (275)	3000 (206)
40 (4)	6000 (413)	6000 (413)	6000 (413)	4000 (275)	3000 (206)
100 (37)	6000 (413)	6000 (413)	6000 (413)	4000 (275)	3000 (206)
150 (65)	5000 (344)	4000 (275)	5000 (344)	2700 (186)	2000 (137)
200 (93)	4000 (275)	2700 (186)	4000 (275)	1400 (96.4)	1000 (68.9)
250 (121)	3000 (206)	1400 (96.4)	3000 (206)	300 (20.6)	300 (20.6)
300 (148)	2000 (137)	400 (27.5)	2000 (137)	—	—
350 (176)	1200 (82.6)	—	1200 (82.6)	—	—
400 (204)	400 (27.5)	—	400 (27.5)	—	—
500 (260)	—	—	200 (13.7)	—	—

QF12 Series and QF16 Series

Material	316 SS			Brass
O-Ring Material	Fluorocarbon FKM	Ethylene propylene	Perfluorocarbon FFKM	Buna N
Temperature °F (°C)	Pressure Rating, psig (bar)			
Coupled				
-50 (-45)	—	4000 (275)	—	—
0 (-17)	4000 (275)	4000 (275)	4000 (275)	2000 (137)
10 (-12)	4000 (275)	4000 (275)	4000 (275)	2000 (137)
40 (4)	4000 (275)	4000 (275)	4000 (275)	2000 (137)
100 (37)	4000 (275)	4000 (275)	4000 (275)	2000 (137)
150 (65)	3500 (241)	2000 (137)	3500 (241)	1300 (89.5)
200 (93)	2800 (192)	1300 (89.5)	2800 (192)	700 (48.2)
250 (121)	2100 (144)	700 (48.2)	2100 (144)	200 (13.7)
300 (148)	1400 (96.4)	200 (13.7)	1400 (96.4)	—
350 (176)	800 (55.1)	—	800 (55.1)	—
400 (204)	200 (13.7)	—	200 (13.7)	—
500 (260)	—	—	150 (10.3)	—

Dimensions

Stems

Tube Fitting

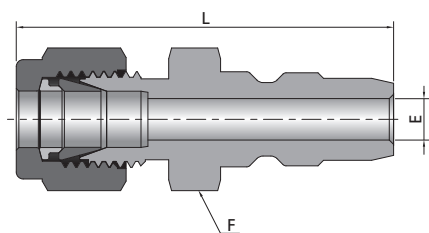

Fitting Size in.	Basic Ordering Number	Flow Coefficient (Cv)	Dimensions		
			E in. (mm)	F in.	L in. (mm)
1/4	-QF4-FL4-S	2.2	0.19 (4.8)	9/16	1.77 (45.0)
3/8	-QF4-FL6-S	2.8	0.24 (6.1)	11/16	1.77 (45.0)
3/8	-QF8-FL6-S	2.8	0.28 (7.1)	7/8	1.88 (47.8)
1/2	-QF8-FL8-S	13.0	0.41 (10.4)	7/8	1.99 (50.5)
3/4	-QF12-FL12-S	26.0	0.62 (15.7)	1 1/16	2.15 (54.6)
1	-QF16-FL16-S	45.0	0.88 (22.4)	1 3/8	2.45 (62.2)
mm	—	—	(mm) in.	mm	(mm) in.
6	-QF4-ML6-S	2.2	4.8 (0.19)	15	45.0 (1.77)
10	-QF8-ML10-S	2.8	7.1 (0.28)	22	48.5 (1.91)
12	-QF8-ML12-S	13.0	9.5 (0.37)	22	51.3 (2.02)
20	-QF12-ML20-S	26.0	15.7 (0.62)	30	54.6 (2.15)
25	-QF16-ML25-S	45.0	22.4 (0.88)	36	63.5 (2.50)

Male NPT

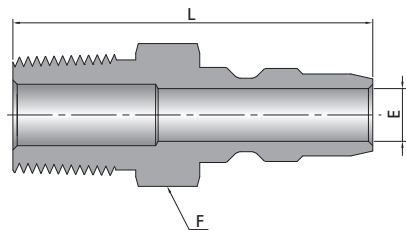

NPT Size in.	Basic Ordering Number	Flow Coefficient (Cv)	Dimensions		
			E in. (mm)	F in.	L in. (mm)
1/4	-QF4-NS4-S	1.7	0.24 (6.1)	9/16	1.59 (40.4)
3/8	-QF4-NS6-S	1.7	0.24 (6.1)	11/16	1.59 (40.4)
3/8	-QF8-NS6-S	7.1	0.41 (10.4)	7/8	1.65 (41.9)
1/2	-QF8-NS8-S	11.5	0.50 (12.7)	7/8	1.84 (46.7)
3/4	-QF12-NS12-S	23.6	0.72 (18.3)	1 1/16	2.03 (51.6)
1	-QF16-NS16-S	39.0	0.88 (22.4)	1 3/8	2.35 (59.7)

Stems

Female NPT

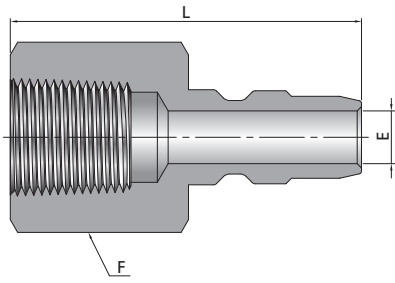

NPT Size in.	Basic Ordering Number	Flow Coefficient (Cv)	Dimensions		
			E	F	L
			in. (mm)	in.	in. (mm)
1/4	-QF4-FNS4-S	1.7	0.24 (6.1)	3/4	1.60 (40.6)
3/8	-QF4-FNS6-S	1.7	0.24 (6.1)	7/8	1.67 (42.4)
3/8	-QF8-FNS6-S	7.1	0.41 (10.4)	1 1/16	1.59 (40.4)
1/2	-QF8-FNS8-S	11.5	0.50 (12.7)	1 1/16	1.82 (46.2)
3/4	-QF12-FNS12-S	23.6	0.72 (18.3)	1 5/16	2.08 (52.8)
1	-QF16-FNS16-S	39.0	0.88 (22.4)	1 5/8	2.49 (63.2)

Male BSPT

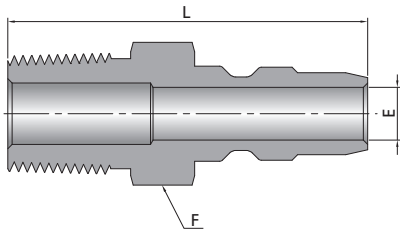

BSPT Size in.	Basic Ordering Number	Flow Coefficient (Cv)	Dimensions		
			E	F	L
			in. (mm)	in.	in. (mm)
1/4	-QF4-RT4-S	1.7	0.24 (6.1)	9/16	1.59 (40.4)
3/8	-QF4-RT6-S	1.7	0.24 (6.1)	11/16	1.59 (40.4)
3/8	-QF8-RT6-S	7.1	0.41 (10.4)	7/8	1.65 (41.9)
1/2	-QF8-RT8-S	11.5	0.50 (12.7)	7/8	1.84 (46.7)
3/4	-QF12-RT12-S	23.6	0.72 (18.3)	1 1/16	2.03 (51.6)
1	-QF16-RT16-S	39.0	0.88 (22.4)	1 3/8	2.35 (59.7)

Female BSPT

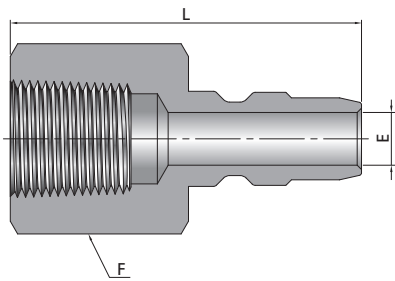

BSPT Size in.	Basic Ordering Number	Flow Coefficient (Cv)	Dimensions		
			E	F	L
			in. (mm)	in.	in. (mm)
1/4	-QF4-FRT4-S	1.7	0.24 (6.1)	3/4	1.60 (40.6)
3/8	-QF4-FRT6-S	1.7	0.24 (6.1)	7/8	1.67 (42.4)
3/8	-QF8-FRT6-S	7.1	0.41 (10.4)	1 1/16	1.59 (40.4)
1/2	-QF8-FRT8-S	11.5	0.50 (12.7)	1 1/16	1.82 (46.2)
3/4	-QF12-FRT12-S	23.6	0.72 (18.3)	1 5/16	2.08 (52.8)
1	-QF16-FRT16-S	39.0	0.88 (22.4)	1 5/8	2.49 (63.2)

Bodies

Tube Fitting

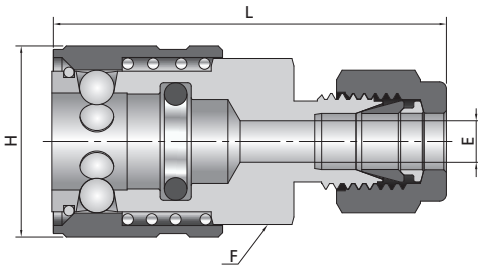

Fitting Size in.	Basic Ordering Number	Dimensions			
		E in. (mm)	F in.	H in. (mm)	L in. (mm)
1/4	-QF4-FL4-B	0.19 (4.8)	11/16	0.87 (22.1)	1.80 (45.7)
3/8	-QF4-FL6-B	0.28 (7.1)	11/16	0.87 (22.1)	1.81 (46.0)
3/8	-QF8-FL6-B	0.28 (7.1)	1 1/16	1.30 (33.0)	2.17 (55.1)
1/2	-QF8-FL8-B	0.47 (11.9)	1 1/16	1.30 (33.0)	2.23 (56.6)
3/4	-QF12-FL12-B	0.62 (15.7)	1 1/2	1.66 (42.2)	2.45 (62.2)
1	-QF16-FL16-B	0.88 (22.4)	1 11/16	1.88 (47.8)	2.75 (69.9)
mm		(mm) in.	mm	(mm) in.	(mm) in.
6	-QF4-ML6-B	4.8 (0.19)	18	22.1 (0.87)	45.7 (1.80)
10	-QF8-ML10-B	7.1 (0.28)	27	33.0 (1.30)	55.9 (2.20)
12	-QF8-ML12-B	10.4 (0.41)	27	33.0 (1.30)	57.4 (2.26)
20	-QF12-ML20-B	15.9 (0.63)	38	42.2 (1.66)	63.5 (2.50)
25	-QF16-ML25-B	21.8 (0.86)	46	47.8 (1.88)	70.0 (2.76)

Male NPT

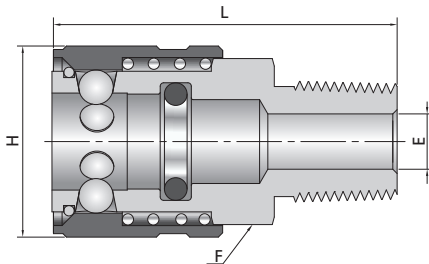

NPT Size in.	Basic Ordering Number	Dimensions			
		E in. (mm)	F in.	H in. (mm)	L in. (mm)
1/4	-QF4-NS4-B	0.25 (6.4)	11/16	0.87 (22.1)	1.57 (39.9)
3/8	-QF4-NS6-B	0.37 (9.4)	11/16	0.87 (22.1)	1.57 (39.9)
3/8	-QF8-NS6-B	0.41 (10.4)	1 1/16	1.30 (33.0)	1.83 (46.5)
1/2	-QF8-NS8-B	0.50 (12.7)	1 1/16	1.30 (33.0)	2.08 (52.8)
3/4	-QF12-NS12-B	0.72 (18.3)	1 1/2	1.66 (42.2)	2.33 (59.2)
1	-QF16-NS16-B	0.88 (22.4)	1 11/16	1.88 (47.8)	2.65 (67.3)

Female NPT

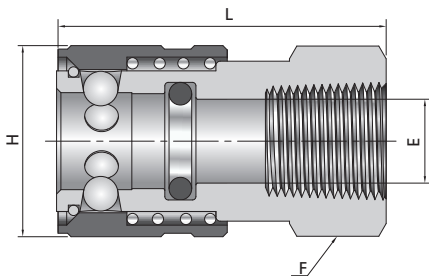

NPT Size in.	Basic Ordering Number	Dimensions			
		E in. (mm)	F in.	H in. (mm)	L in. (mm)
1/4	-QF4-FNS4-B	0.38 (9.7)	3/4	0.87 (22.1)	1.50 (38.1)
3/8	-QF4-FNS6-B	0.38 (9.7)	7/8	0.87 (22.1)	1.63 (41.4)
3/8	-QF8-FNS6-B	0.59 (15.0)	1 1/16	1.30 (33.0)	1.73 (43.9)
1/2	-QF8-FNS8-B	0.63 (16.0)	1 1/16	1.30 (33.0)	1.73 (43.9)
3/4	-QF12-FNS12-B	0.88 (22.4)	1 1/2	1.66 (42.2)	1.89 (48.0)
1	-QF16-FNS16-B	1.06 (26.9)	1 11/16	1.88 (47.8)	2.12 (53.8)

Male BSPT

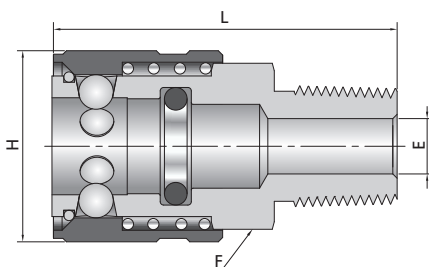

BSPT Size in.	Basic Ordering Number	Dimensions			
		E in. (mm)	F in.	H in. (mm)	L in. (mm)
1/4	-QF4-RT4-B	0.25 (6.4)	11/16	0.87 (22.1)	1.57 (39.9)
3/8	-QF4-RT6-B	0.37 (9.4)	11/16	0.87 (22.1)	1.57 (39.9)
3/8	-QF8-RT6-B	0.41 (10.4)	1 1/16	1.30 (33.0)	1.83 (46.5)
1/2	-QF8-RT8-B	0.50 (12.7)	1 1/16	1.30 (33.0)	2.08 (52.8)
3/4	-QF12-RT12-B	0.72 (18.3)	1 1/2	1.66 (42.2)	2.33 (59.2)
1	-QF16-RT16-B	0.88 (22.4)	1 11/16	1.88 (47.8)	2.65 (67.3)

Female BSPT

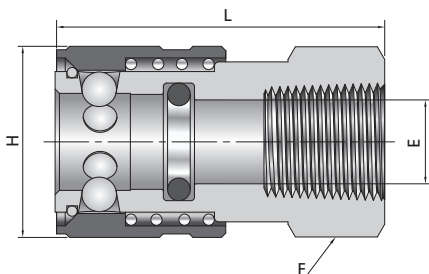

BSPT Size in.	Basic Ordering Number	Dimensions			
		E in. (mm)	F in.	H in. (mm)	L in. (mm)
1/4	-QF4-FRT4-B	0.38 (9.7)	3/4	0.87 (22.1)	1.50 (38.1)
3/8	-QF4-FRT6-B	0.38 (9.7)	7/8	0.87 (22.1)	1.63 (41.4)
3/8	-QF8-FRT6-B	0.59 (15.0)	1 1/16	1.30 (33.0)	1.73 (43.9)
1/2	-QF8-FRT8-B	0.63 (16.0)	1 1/16	1.30 (33.0)	1.73 (43.9)
3/4	-QF12-FRT12-B	0.88 (22.4)	1 1/2	1.66 (42.2)	1.89 (48.0)
1	-QF16-FRT16-B	1.06 (26.9)	1 11/16	1.88 (47.8)	2.12 (53.8)

Hoses Quick-Connects

Options, QF Series

Stem and Body Protector

Stem and body protector can prevent the stem and the body from being damaged and polluted when uncoupling.

Stem Protector

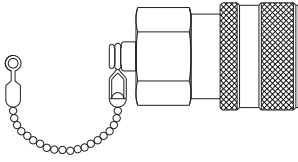

Series	Basic Ordering Number
QF4	-QF4-SP
QF8	-QF8-SP
QF12	-QF12-SP
QF16	-QF16-SP

Body Protector

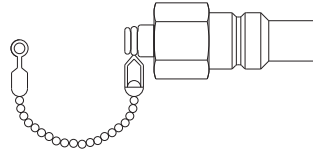

Series	Basic Ordering Number
QF4	-QF4-BP
QF8	-QF8-BP
QF12	-QF12-BP
QF16	-QF16-BP

Ordering number description of the protector: material designator (SS for stainless steel or B for brass) + basic ordering number.

Example: **SS-QF4-BP**

The protector is not a pressure sustaining device. To order pressure sustaining device, please contact FITOK Group or our authorized distributors.

Ordering Number Description

SS - QF4 - FNS4 - B - B - CE

Material		Series		End Connection Type		End Connection Size		Stem or Body		O-ring Material		Special Application	
SS	316SS	QF4	1/4" (6.4 mm)	FNS	Female NPT	4	1/4"	S	Stem		Fluorocarbon FKM		No
B	Brass	QF8	1/2" (12.7 mm)	NS	Male NPT	6	3/8" or 6 mm	B	Body	B	Buna N	CE	NACE MR0175
		QF12	3/4" (19.0 mm)	FRT	Female BSPT	8	1/2" or 8 mm			E	EPDM	SI	SilcoNert® 2000 (Sulfinert®) Coating
		QF16	1" (25.4 mm)	RT	Male BSPT	10	5/8" or 10 mm			N	Neoprene		
				FMS	Female Metric Thread (for RG-M)	12	3/4" or 12 mm			Z	FFKM		
				MS	Male Metric Thread (for RG-M)	14	M14 x 1.5						
				FL	Fractional Tube Fitting	16	1" or 16 mm						
				ML	Metric Tube Fitting	18	M18 x 1.5						
				FT	Fractional Tube Adapter	20	M20 x 1.5						
				MT	Metric Tube Adapter								
				AN	Male JIC 37° Flare								

Note: 1. "Ordering Number Description" is a reference to understand the combination rules of FITOK product part number. Not all combinations are available.

2. Dimensions are for reference only and are subject to change.

3. Special Application

Wetted metal components SilcoNert® 2000 (Sulfinert®) coated.

QV Series

Features

- ⦿ Working pressure up to: 2000 psig (137 bar)
- ⦿ Large flow area to ensure high flow capacity
- ⦿ Positive valve stop to maintain valve alignment and to provide metal to metal valve stop to ensure that the valves are fully open
- ⦿ Hardened nipples and sleeves as well as solid barstock construction to make for a quality coupling with maximum resistance to damage from hydraulic and mechanical shock
- ⦿ Designed to withstand high pressure with reliable sealing
- ⦿ Durable ball-locking mechanism to assure reliable connection

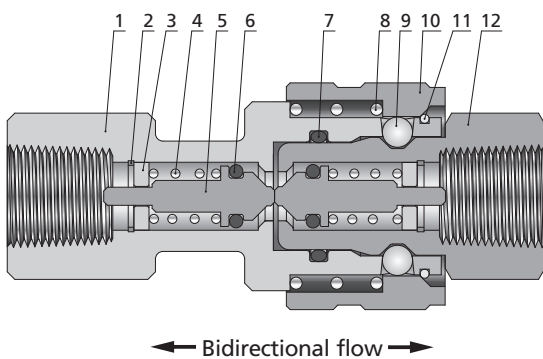

Standard Materials of Construction

Item	Component	Material Grade/ASTM Specification	
		Stainless Steel	Brass
1	Body	316 SS/A479	C36000/B16
2	Locating ring	304 SS	
3	Locating block	316 SS/A276	Brass C36000/B16
4	Springs	316 SS/A313	
5	Valve Stem	316 SS/A479	C36000/B16
6	O-rings	Fluorocarbon FKM	Buna N
7			
8	Springs	316 SS/A313	
9	Locking balls	440C/A276	
10	Body sleeve	316L SS/A479	Brass C36000/B16
11	Snap rings	316 SS/A313	
12	Stem	316 SS/A479	C36000/B16
13	Lubricants	Silicone-based	

Pressure-Temperature Ratings

Do not couple or uncouple under pressure.

Body Material	Stainless Steel						Brass					
	Series	QV2	QV4	QV6	QV8	QV12	QV16	QV2	QV4	QV6	QV8	QV12
O-ring	FKM						Buna N					
Temperature Range	-10°F to 400°F (-23°C to 204°C)						-10°F to 250°F (-23°C to 121°C)					
Working Pressure psig (bar)	2000 (137)		1500 (103)		1000 (69.0)		1000 (69.0)					

Insertion Depth

Series	Insertion Depth
	in. (mm)
QV2	0.81 (20.5)
QV4	0.98 (25)
QV6	1.17 (29.7)
QV8	1.26 (32)
QV12	1.64 (41.6)
QV16	1.93 (49.1)

In order to measure overall length in the coupled position, the insertion depth should be deducted from any overall stem and body combination length.

Hoses
Quick-Connects

Dimensions

Stems

Female NPT

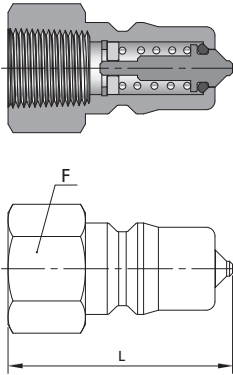

NPT Size in.	Basic Ordering Number	Flow Coefficient (Cv)	Dimensions	
			L	F
			in. (mm)	in.
1/8	-QV2-FNS2-D	0.2	1.16 (29.5)	9/16
1/4	-QV4-FNS4-D	0.6	1.39 (35.3)	3/4
3/8	-QV6-FNS6-D	1.2	1.50 (38.1)	7/8
1/2	-QV8-FNS8-D	2.6	1.75 (44.5)	1 1/8
3/4	-QV12-FNS12-D	3.3	2.16 (54.9)	1 3/8
1	-QV16-FNS16-D	6.2	2.91 (73.9)	1 5/8

Female BSPT

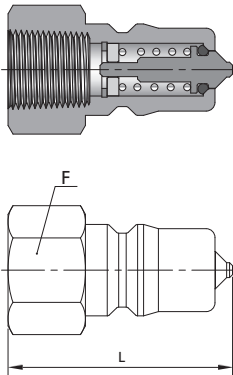

BSPT Size in.	Basic Ordering Number	Flow Coefficient (Cv)	Dimensions	
			L	F
			in. (mm)	in.
1/8	-QV2-FRT2-D	0.2	1.16 (29.5)	9/16
1/4	-QV4-FRT4-D	0.6	1.39 (35.3)	3/4
3/8	-QV6-FRT6-D	1.2	1.50 (38.1)	7/8
1/2	-QV8-FRT8-D	2.6	1.75 (44.5)	1 1/8
3/4	-QV12-FRT12-D	3.3	2.16 (54.9)	1 3/8
1	-QV16-FRT16-D	6.2	2.91 (73.9)	1 5/8

Bodies

Female NPT

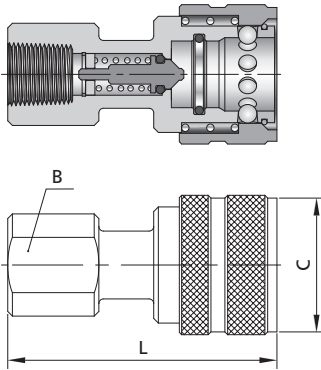

NPT Size in.	Basic Ordering Number	Dimensions		
		L	B	C
		in. (mm)	in. (mm)	in. (mm)
1/8	-QV2-FNS2-B	1.90 (48.3)	0.63 (15.9)	0.96 (24.4)
1/4	-QV4-FNS4-B	2.26 (57.4)	0.81 (20.6)	1.14 (29.0)
3/8	-QV6-FNS6-B	2.49 (63.2)	0.88 (22.2)	1.40 (35.6)
1/2	-QV8-FNS8-B	2.87 (72.9)	1.13 (28.6)	1.77 (45.0)
3/4	-QV12-FNS12-B	3.56 (90.4)	1.31 (33.3)	2.14 (54.4)
1	-QV16-FNS16-B	4.18 (106.2)	1.63 (41.3)	2.52 (64.0)

Female BSPT

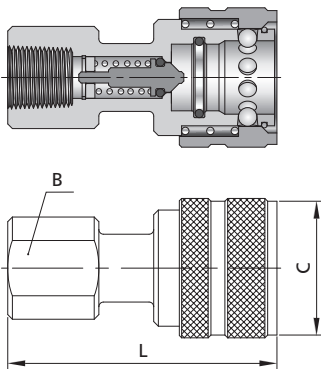

BSPT Size in.	Basic Ordering Number	Dimensions		
		L	B	C
		in. (mm)	in. (mm)	in. (mm)
1/8	-QV2-FRT2-B	1.90 (48.3)	0.69 (17.5)	0.96 (24.4)
1/4	-QV4-FRT4-B	2.26 (57.4)	0.81 (20.6)	1.14 (29.0)
3/8	-QV6-FRT6-B	2.49 (63.2)	0.88 (22.2)	1.40 (35.6)
1/2	-QV8-FRT8-B	2.87 (72.9)	1.13 (28.6)	1.77 (45.0)
3/4	-QV12-FRT12-B	3.56 (90.4)	1.31 (33.3)	2.14 (54.4)
1	-QV16-FRT16-B	4.18 (106.2)	1.63 (41.3)	2.52 (64.0)

Options, QV Series

Stem and Body Protector

Stem and body protector can prevent the stem and the body from being damaged and polluted when uncoupling.

Stem Protector

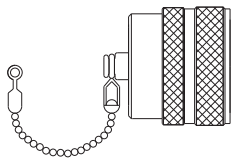

Series	Basic Ordering Number
QV2	-QV2-SP
QV4	-QV4-SP
QV6	-QV6-SP
QV8	-QV8-SP
QV12	-QV12-SP
QV16	-QV16-SP

Body Protector

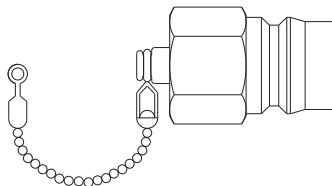

Series	Basic Ordering Number
QV2	-QV2-BP
QV4	-QV4-BP
QV6	-QV6-BP
QV8	-QV8-BP
QV12	-QV12-BP
QV16	-QV16-BP

- Ordering number description of the protector: material designator (SS for stainless steel or B for brass) + basic ordering number.
Example: **SS-QV4-BP**
- The protector is not a pressure sustaining device. To order pressure sustaining device, please contact FITOK Group or our authorized distributors.

Ordering Number Description

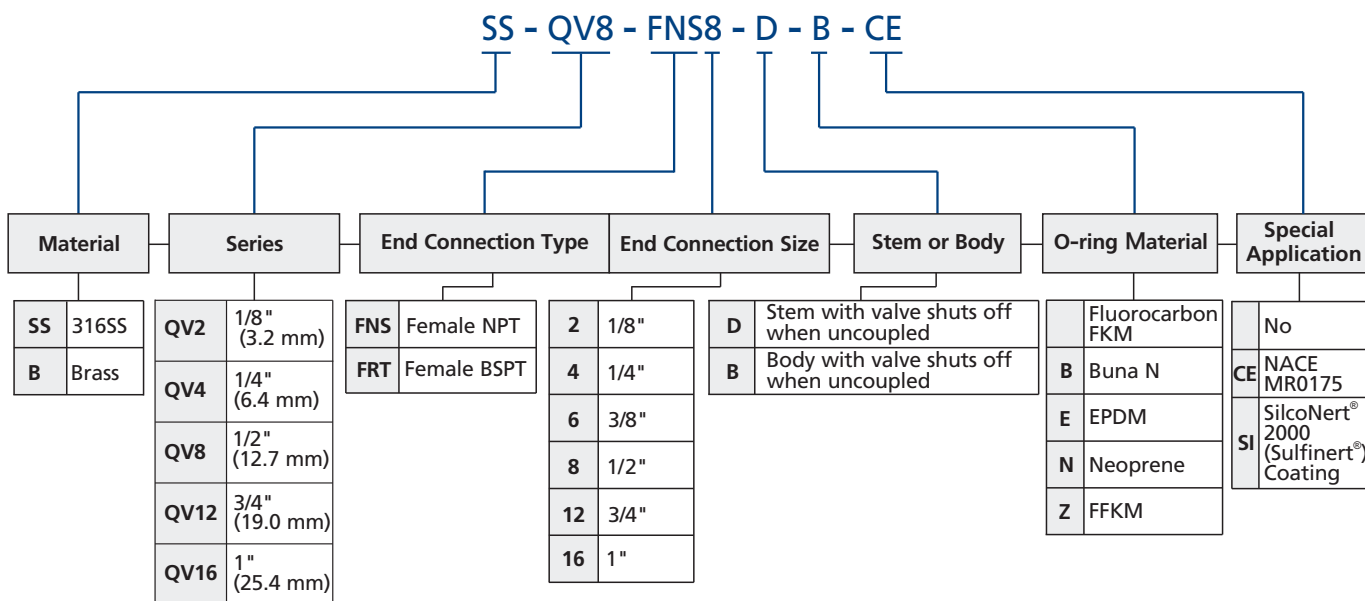

- Note: 1. "Ordering Number Description" is a reference to understand the combination rules of FITOK product part number. Not all combinations are available.
 2. Dimensions are for reference only and are subject to change.
 3. Special Application
 Wetted metal components SilcoNert® 2000 (Sulfinert®) coated.

QM Series

Features

- Working pressure up to: 4000 psig (276 bar)
- Single-end shutoff, double-end shutoff and full-flow model available
- Quick and easy operation

Double-end Shutoff (DESO)

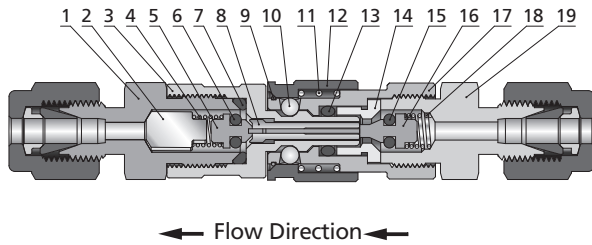

Single-end Shutoff (SESO)

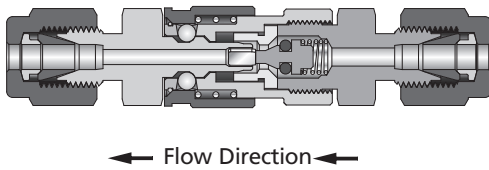

Full-flow Quick-Connects

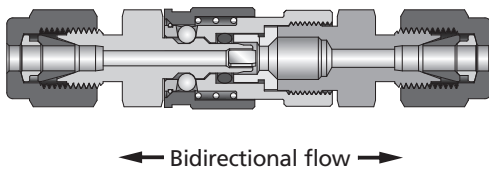

Insertion Depth

In order to measure overall length in the coupled position, insertion depth should be deducted from any overall stem and body combination length.

Depth in. (mm)	
SESO	DESO
0.47 (11.9)	0.53 (13.5)

Spillage and Air Inclusion

0.1cm³
(DESO only)

Standard Materials of Construction

Item.	Component	Material Grade/ASTM Specification	
		Stainless Steel	Brass
1	Stem body	316 SS/A479	Brass C36000/B16
2	Valve block	316 SS/A240	Brass C26000/B36
3	Stem	316 SS/A479	Brass C36000/B16
4	Springs	316 SS/A313	
5	Valve head	316 SS/A479	Brass C36000/B16
6	O-rings	Fluorocarbon FKM	
7		Buna N	
8	Stem insert	316 SS/A240	Brass C26000/B36
9	Snap rings	316 SS/A313	
10	Steel ball	440C/A276	
11	Springs	316 SS/A313	
12	Body sleeve	316L SS/A479	Brass C36000/B16
13	O-rings	Fluorocarbon FKM	Buna N
14	Insert	316 SS/A479	Brass C36000/B16
15	O-rings	Fluorocarbon FKM	Buna N
16	Valve head	316 SS/A479	Brass C36000/B16
17	housing	316 SS/A479	Brass C36000/B16
18	Springs	316 SS/A313	
19	Body	316 SS/A479	Brass C36000/B16
20	Lubricants	Silicone-based	

Pressure -Temperature Ratings

Pressure rating restrictions apply when coupling and uncoupling (DESO only). Refer to the table below for specific data.

Material	316 SS			Brass
	Fluorocarbon FKM	Ethylene propylene	Perfluorocarbon FFKM	Buna N
O-Ring Material				
Temperature °F (°C)	Pressure Rating, psig (bar)			
Coupled				
-50 (-45)	—	4000 (275)	—	—
0 (-17)	4000 (275)	4000 (275)	4000 (275)	2000 (137)
10 (-12)	4000 (275)	4000 (275)	4000 (275)	2000 (137)
40 (4)	4000 (275)	4000 (275)	4000 (275)	2000 (137)
100 (37)	4000 (275)	4000 (275)	4000 (275)	2000 (137)
150 (65)	3500 (241)	3500 (241)	3500 (241)	1300 (89.5)
200 (93)	2800 (192)	2800 (192)	2800 (192)	700 (48)
250 (121)	2100 (144)	2100 (144)	2100 (144)	200 (13.7)
300 (148)	1400 (96.4)	1400 (96.4)	1400 (96.4)	—
350 (176)	800 (55.1)	—	800 (55.1)	—
400 (204)	200 (13.7)	—	200 (13.7)	—
500 (260)	—	—	150 (10.3)	—
Uncoupled and When Coupling and Uncoupling				
70 (20)	100 (6.8)			

Dimensions

SESO Stems

Tube Fitting

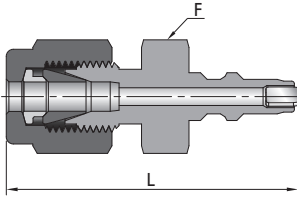

Fitting Size in.	Basic Ordering Number	Flow Coefficient (Cv)	Dimensions	
			L	F
			in. (mm)	in.
1/16	QM-FL1-S	0.06	1.18 (30.0)	7/16
1/8	QM-FL2-S		1.29 (32.8)	

Male NPT

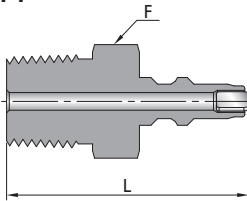

NPT Size in.	Basic Ordering Number	Flow Coefficient (Cv)	Dimensions	
			L	F
			in. (mm)	in.
1/16	QM-NS1-S	0.06	1.03 (26.2)	7/16
1/8	QM-NS2-S			

Female NPT

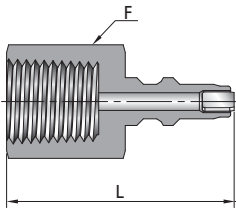

NPT Size in.	Basic Ordering Number	Flow Coefficient (Cv)	Dimensions	
			L	F
			in. (mm)	in.
1/16	QM-FNS1-S	0.06	1.03 (26.2)	7/16
1/8	QM-FNS2-S		1.18 (30.0)	9/16

DESO Stems

Tube Fitting

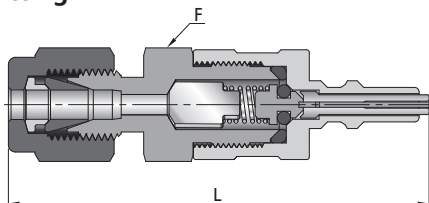

Fitting Size in.	Basic Ordering Number	Flow Coefficient (Cv)	Dimensions	
			L	F
			in. (mm)	in.
1/16	QM-FL1-D	0.05	1.76 (44.7)	7/16
1/8	QM-FL2-D		1.87 (47.5)	

Male NPT

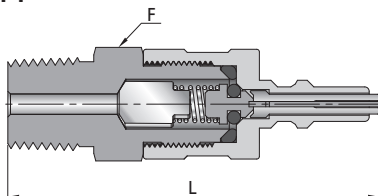

NPT Size in.	Basic Ordering Number	Flow Coefficient (Cv)	Dimensions	
			L	F
			in. (mm)	in.
1/16	QM-NS1-D	0.05	1.61 (40.9)	7/16
1/8	QM-NS2-D			

Female NPT

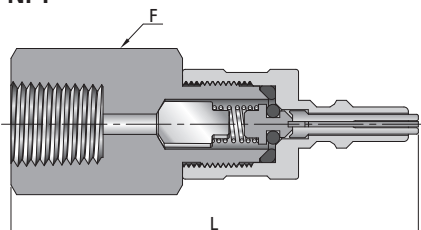

NPT Size in.	Basic Ordering Number	Flow Coefficient (Cv)	Dimensions	
			L	F
			in. (mm)	in.
1/16	QM-FNS1-D	0.05	1.61 (40.9)	7/16
1/8	QM-FNS2-D		1.81 (46.0)	9/16

Bodies

Tube Fitting

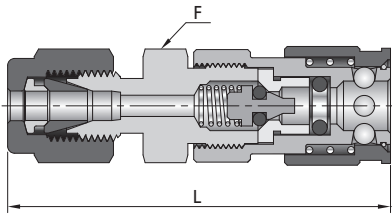

Fitting Size in.	Basic Ordering Number	Dimensions	
		L	F
		in. (mm)	in.
1/16	QM-FL1-B	1.50 (38.1)	7/16
1/8	QM-FL2-B	1.70 (43.2)	

Male NPT

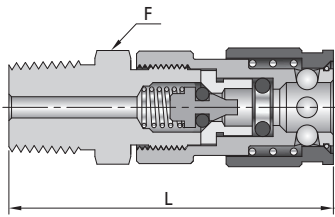

NPT Size in.	Basic Ordering Number	Dimensions	
		L	F
		in. (mm)	in.
1/16	QM-NS1-B	1.42 (36.1)	7/16
1/8	QM-NS2-B	1.44 (36.6)	

Female NPT

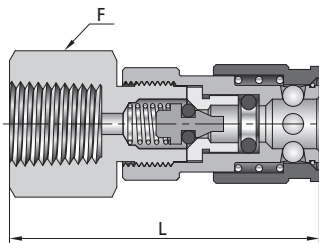

NPT Size in.	Basic Ordering Number	Dimensions	
		L	F
		in. (mm)	in.
1/16	QM-FNS1-B	1.43 (36.3)	7/16
1/8	QM-FNS2-B	1.62 (41.1)	9/16

Bulkhead Tube Fitting

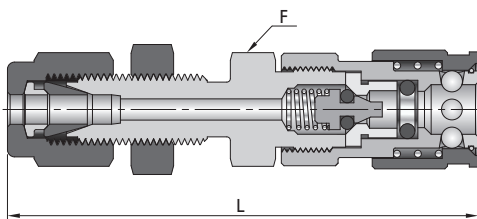

Fitting Size in.	Basic Ordering Number	Dimensions		Min. Panel Hole in. (mm)	Max. Panel Thickness in. (mm)
		A	F		
		in. (mm)	in.		
1/8	QM-BFL2-B	2.09 (53.1)	7/16	0.33 (8.3)	0.25 (6.4)

Full-flow Bodies

Tube Fitting

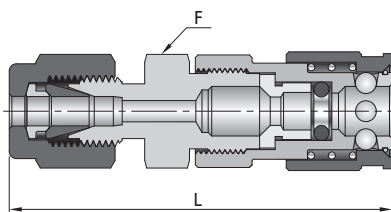

Fitting Size in.	Basic Ordering Number	Flow Coefficient (Cv)	Dimensions	
			L	F
			in. (mm)	in.
1/16	QM-FL1-F	0.06	1.50 (38.1)	7/16
1/8	QM-FL2-F		1.70 (43.2)	

Male NPT

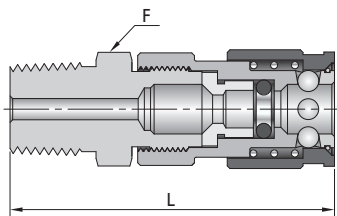

Fitting Size in.	Basic Ordering Number	Flow Coefficient (Cv)	Dimensions	
			L in. (mm)	F in.
1/16	QM-NS1-F	0.06	1.42 (36.1)	7/16
1/8	QM-NS2-F		1.44 (36.6)	

Female NPT

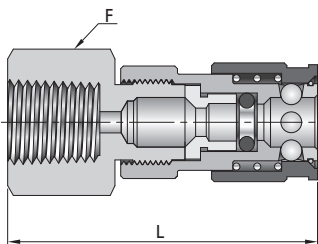

NPT Size in.	Basic Ordering Number	Flow Coefficient (Cv)	Dimensions	
			L in. (mm)	F in.
1/16	QM-FNS1-F	0.06	1.43 (36.3)	7/16
1/8	QM-FNS2-F		1.62 (41.1)	9/16

Ordering Number Description

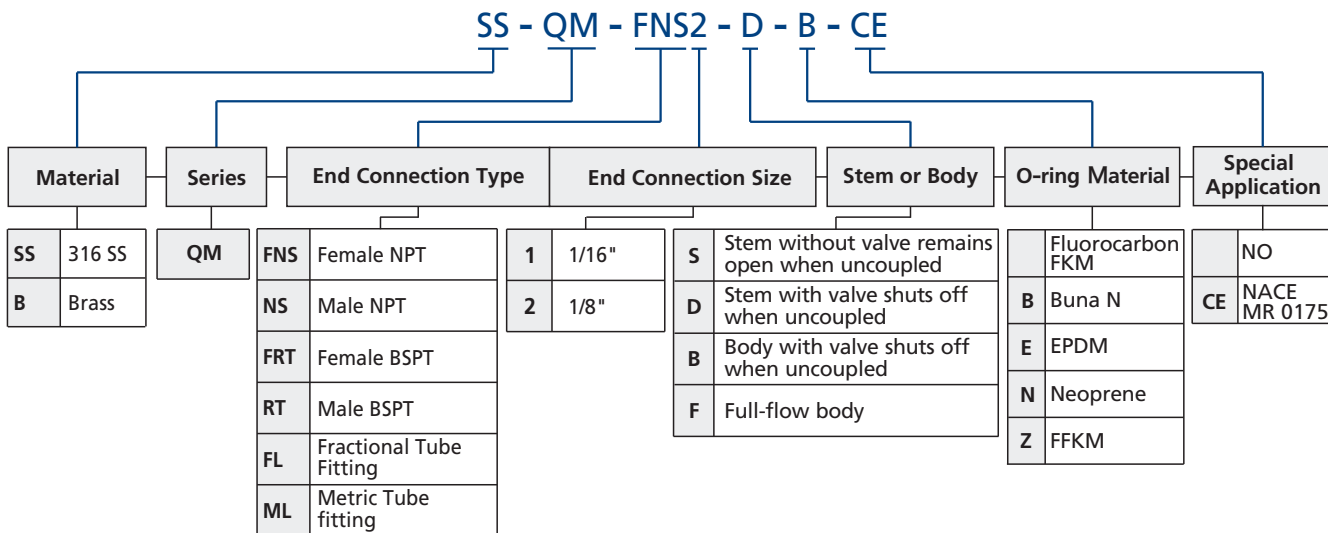

Note: 1. "Ordering Number Description" is a reference to understand the combination rules of FITOK product part number. Not all combinations are available.
 2. Dimensions are for reference only and are subject to change.

QTM Series

Features

- Working pressure up to: 4500 psig (310 bar)
- Special design to reduce air inclusion and spillage
- PTFE sealing to enable applications for diverse media types
- Push-to-connect design to enable quick and easy operation
- Locking mechanism with large contact area to ensure reliable stem retainment
- Keyed option available

Double-end Shutoff (DESO)

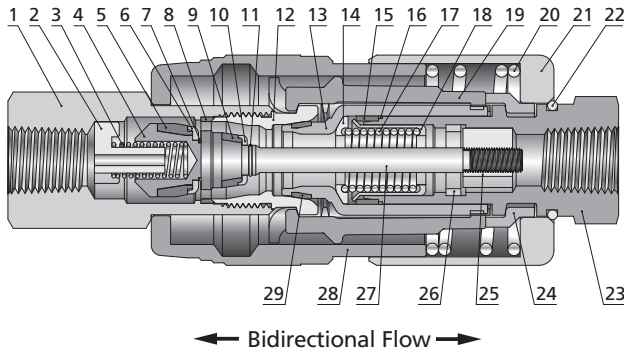

Single-end Shutoff (SESO)

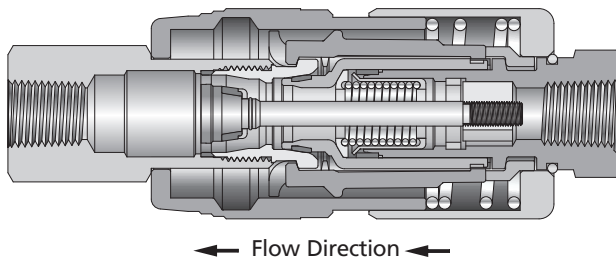

Pressure - Temperature Ratings

Temperature °F (°C)	316 SS			Alloy 400
	QTM2	QTM4	QTM8	QTM2
Pressure Rating, psig (bar)				
Coupled				
0~120 (-17~48)	4500 (310)	3200 (220)	3200 (220)	3200 (220)
Uncoupled				
0~120 (-17~48)	1000 (68.9)			
When Coupling and Uncoupling				
70 (20)	250 (17.2)	100 (6.8)	50 (3.4)	250 (17.2)

Note: Pressure ratings may be restricted by end connections.

Standard Materials of Construction

Item	Component	Material	
1	Stem	316 SS/A479	Alloy 400/B164
2	Spring seat	316 SS/A479	Alloy 400/B164
3	Spring	316 SS/313	Alloy X-750/ AMS 5699
4	DESO valve	316 SS/A479	Alloy 400/B164
5	DESO seal ring	PTFE/D1710	PTFE/D1710
6	DESO stem fin	316 SS/A479	Alloy 400/B164
7	Roundwire snap ring for shaft	316 SS/A313	Alloy X-750/ AMS 5699
8	Adapter seal gasket	PTFE/D1710	PTFE/D1710
9	Body valve seal ring	PTFE/D1710	PTFE/D1710
10	Body fin	316 SS/A479	Alloy 400/B164
11	Roundwire snap ring for shaft	316 SS/A313	Alloy X-750/ AMS 5699
12	Stem adapter	316 SS/A479	Alloy 400/B164
13	Body sliding sleeve	316 SS/A479	Alloy 400/B164
14	Spring pad	316 SS/A479	Alloy 400/B164
15	Body packing ring	PTFE/D1710	PTFE/D1710
16	Packing backup ring	PTFE/D1710	PTFE/D1710
17	Spring	Elgiloy Alloy	Elgiloy Alloy
18	Body insert	316 SS/A479	Alloy 400/B164
19	Sliding hooks with spring ring	316 SS/A479	Alloy 400/B164
20	Spring	316 SS/A313	Alloy X-750/ AMS 5699
21	Body valve cap 2	316 SS/A479	Alloy 400/B164
22	Roundwire snap rings for shaft	316 SS/A313	Alloy X-750/ AMS 5699
23	Body	Xylan-coated 316 SS/A479	Xylan-coated alloy 400/B164
24	Locking block	316 SS/A479	Alloy 400/B164
25	Threaded connecting ring	316 SS/A479	Alloy 400/B164
26	Retaining ring	316 SS/A313	Alloy X-750/ AMS 5699
27	Body bolt	316 SS/A479	Alloy 400/B164
28	Body valve cap 1	316 SS/A479	Alloy 400/B164
29	Body valve seal ring	PTFE/D1710	PTFE/D1710
30	Lubricants	PTFE-based	PTFE-based

Spillage and Air Inclusion

DESO only

Series	Spillage cm ³	Air Inclusion cm ³
QTM2	0.1	0.1
QTM4	0.2	0.4
QTM8	1.0	2.0

Insertion Depth

Series	Depth in. (mm)
QTM2	1.26 (32.1)
QTM4	0.95 (24.0)
QTM8	1.15 (29.1)

In order to measure overall length in the coupled position, insertion depth should be deducted from any overall stem and body combination length.

Dimensions

DESO Stems

Tube Fitting

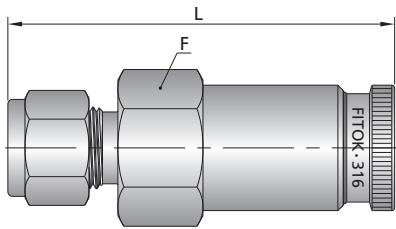

Fitting Size in.	Basic Ordering Number	Flow Coefficient (Cv)	Dimensions	
			L	F
			in. (mm)	in.
1/4	-QTM2-FL4-D	0.6	2.02 (51.3)	5/8
1/4	-QTM4-FL4-D	0.8	2.61 (66.3)	15/16
3/8	-QTM2-FL6-D	0.8	2.08 (52.8)	11/16
3/8	-QTM4-FL6-D	1.6	2.67 (67.8)	15/16
1/2	-QTM8-FL8-D	3.1	3.06 (77.7)	1 5/16
3/4	-QTM8-FL12-D	6.5	3.06 (77.7)	1 5/16
1	-QTM8-FL16-D	7.8	3.27 (83.1)	1 3/8
mm	—	—	mm (in.)	mm
6	-QTM2-ML6-D	0.6	51.3 (2.02)	16
6	-QTM4-ML6-D	0.8	66.3 (2.61)	24
8	-QTM2-ML8-D	0.8	53.1 (2.09)	11/16 in.
10	-QTM4-ML10-D	1.6	68.1 (2.68)	24
12	-QTM8-ML12-D	3.1	77.7 (3.06)	35

Female NPT

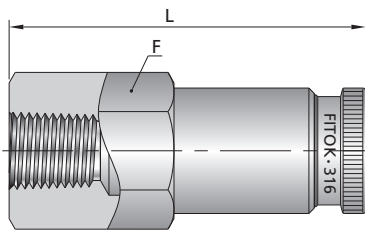

NPT Size in.	Basic Ordering Number	Flow Coefficient (Cv)	Dimensions	
			L	F
			in. (mm)	in.
1/8	-QTM2-FNS2-D	0.7	1.73 (43.9)	5/8
1/4	-QTM2-FNS4-D	0.7	2.04 (51.8)	3/4
1/4	-QTM4-FNS4-D	1.4	2.36 (59.9)	15/16
3/8	-QTM2-FNS6-D	0.6	2.14 (54.4)	7/8
3/8	-QTM4-FNS6-D	1.7	2.48 (63.0)	15/16
1/2	-QTM8-FNS8-D	4.4	2.66 (67.6)	1 5/16
3/4	-QTM8-FNS12-D	7.8	2.66 (67.6)	1 5/16
1	-QTM8-FNS16-D	—	3.17 (80.5)	1 5/8

Female BSPT

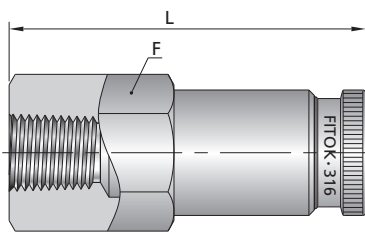

BSPT Size in.	Basic Ordering Number	Flow Coefficient (Cv)	Dimensions	
			L	F
			in. (mm)	in.
1/8	-QTM2-FRT2-D	0.7	1.73 (43.9)	5/8
1/4	-QTM2-FRT4-D	0.7	2.04 (51.8)	3/4
1/4	-QTM4-FRT4-D	1.4	2.36 (59.9)	15/16
3/8	-QTM2-FRT6-D	0.6	2.14 (54.4)	7/8
3/8	-QTM4-FRT6-D	1.7	2.48 (63.0)	15/16
1/2	-QTM8-FRT8-D	4.4	2.66 (67.6)	1 5/16
3/4	-QTM8-FRT12-D	7.8	2.66 (67.6)	1 5/16
1	-QTM8-FRT16-D	—	3.17 (80.5)	1 5/8

Male NPT

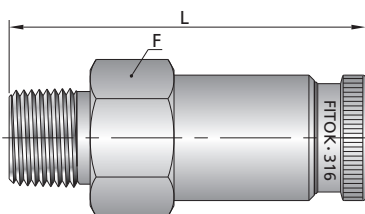

NPT Size in.	Basic Ordering Number	Flow Coefficient (Cv)	Dimensions	
			L	F
			in. (mm)	in.
1/4	-QTM2-NS4-D	0.2	1.91 (48.5)	5/8
1/4	-QTM4-NS4-D	1.4	2.46 (62.5)	15/16
3/8	-QTM2-NS6-D	0.6	2.04 (51.8)	3/4
3/8	-QTM4-NS6-D	1.7	2.46 (62.5)	15/16
1/2	-QTM8-NS8-D	4.4	2.78 (70.6)	1 5/16
3/4	-QTM8-NS12-D	7.8	2.78 (70.6)	1 5/16
1	-QTM8-NS16-D	—	3.03 (77.0)	1 3/8

D-50 Quick-Connects

Male BSPT

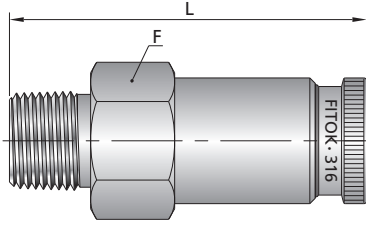

BSPT Size in.	Basic Ordering Number	Flow Coefficient (Cv)	Dimensions	
			L	F
			in. (mm)	in.
1/4	-QTM2-RT4-D	0.2	1.91 (48.5)	5/8
1/4	-QTM4-RT4-D	1.4	2.46 (62.5)	15/16
3/8	-QTM2-RT6-D	0.6	2.04 (51.8)	3/4
3/8	-QTM4-RT6-D	1.7	2.46 (62.5)	15/16
1/2	-QTM8-RT8-D	4.4	2.78 (70.6)	1 5/16
3/4	-QTM8-RT12-D	7.8	2.78 (70.6)	1 5/16
1	-QTM8-RT16-D	—	3.03 (77.0)	1 3/8

Male JIC (AN) 37° Flare

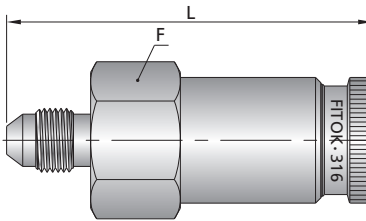

Fitting Size in.	Basic Ordering Number	Flow Coefficient (Cv)	Dimensions	
			L	F
			in. (mm)	in.
1/4	-QTM4-AN4-D	—	2.52 (64.0)	15/16
1/2	-QTM8-AN8-D	2.7	2.46 (70.6)	1 5/16

Bulkhead Tube Fitting

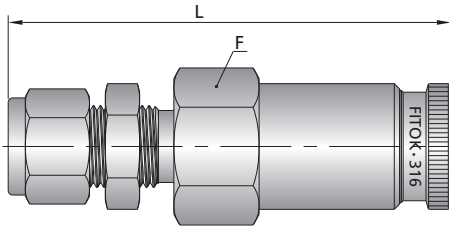

Fitting Size in.	Basic Ordering Number	Flow Coefficient (Cv)	Dimensions		Min. Panel Orifice in. (mm)	Max. Panel Thickness in. (mm)
			L	F		
			in. (mm)	in.		
1/4	-QTM4-BFL4-D	0.8	3.05 (77.5)	15/16	0.46 (11.7)	0.15 (3.8)
3/8	-QTM4-BFL6-D	1.6	3.05 (77.5)	15/16	0.58 (14.7)	0.15 (3.8)
1/2	-QTM8-BFL8-D	3.1	3.54 (89.9)	1 5/16	0.77 (19.6)	0.19 (4.8)
mm	—	—	mm (in.)	mm	mm (in.)	mm (in.)
6	-QTM4-BML6-D	0.8	77.5 (3.05)	24	11.7 (0.46)	3.8 (0.15)
10	-QTM4-BML10-D	1.6	77.7 (3.06)	24	16.8 (0.66)	3.8 (0.15)
12	-QTM8-BML12-D	3.1	89.9 (3.54)	35	19.6 (0.77)	4.8 (0.19)

SESO Stem

Tube Fitting

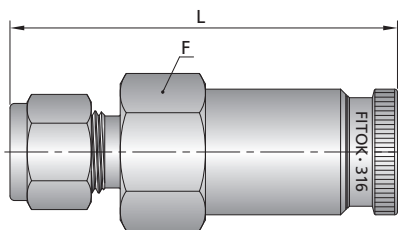

Fitting Size in.	Basic Ordering Number	Flow Coefficient (Cv)	Dimensions	
			L	F
			in. (mm)	in.
1/4	-QTM2-FL4-S	0.7	2.02 (51.3)	5/8
1/4	-QTM4-FL4-S	0.9	2.61 (66.3)	15/16
3/8	-QTM2-FL6-S	0.9	2.08 (52.8)	11/16
3/8	-QTM4-FL6-S	1.7	2.67 (67.8)	15/16
1/2	-QTM8-FL8-S	4.2	3.06 (77.7)	1 5/16
3/4	-QTM8-FL12-S	6.7	3.06 (77.7)	1 5/16
1	-QTM8-FL16-S	9.0	3.27 (83.1)	1 3/8
mm			mm (in.)	mm
6	-QTM2-ML6-S	0.7	51.3 (2.02)	16
6	-QTM4-ML6-S	0.9	66.3 (2.61)	24
8	-QTM2-ML8-S	0.9	53.1 (2.09)	11/16 in.
10	-QTM4-ML10-S	1.7	68.1 (2.68)	24
12	-QTM8-ML12-S	4.2	77.7 (3.06)	35

Female NPT

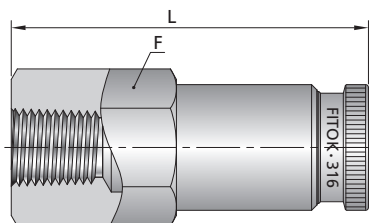

NPT Size in.	Basic Ordering Number	Flow Coefficient (Cv)	Dimensions	
			L	F
			in. (mm)	in.
1/8	-QTM2-FNS2-S	0.7	1.73 (43.9)	5/8
1/4	-QTM2-FNS4-S	0.7	2.04 (51.8)	3/4
1/4	-QTM4-FNS4-S	1.4	2.36 (59.9)	15/16
3/8	-QTM2-FNS6-S	0.7	2.14 (54.4)	7/8
3/8	-QTM4-FNS6-S	1.8	2.48 (63.0)	15/16
1/2	-QTM8-FNS8-S	5.1	2.66 (67.6)	1 5/16
3/4	-QTM8-FNS12-S	8.5	2.66 (67.6)	1 5/16
1	-QTM8-FNS16-S	—	3.17 (80.5)	1 5/8

Female BSPT

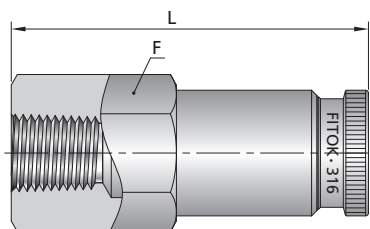

BSPT Size in.	Basic Ordering Number	Flow Coefficient (Cv)	Dimensions	
			L	F
			in. (mm)	in.
1/8	-QTM2-FRT2-S	0.7	1.73 (43.9)	5/8
1/4	-QTM2-FRT4-S	0.7	2.04 (51.8)	3/4
1/4	-QTM4-FRT4-S	1.4	2.36 (59.9)	15/16
3/8	-QTM2-FRT6-S	0.7	2.14 (54.4)	7/8
3/8	-QTM4-FRT6-S	1.8	2.48 (63.0)	15/16
1/2	-QTM8-FRT8-S	5.1	2.66 (67.6)	1 5/16
3/4	-QTM8-FRT12-S	8.5	2.66 (67.6)	1 5/16
1	-QTM8-FRT16-S	—	3.17 (80.5)	1 5/8

Male NPT

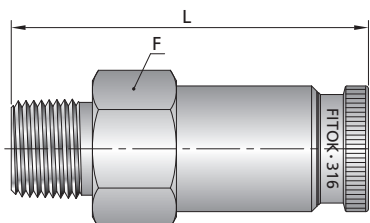

NPT Size in.	Basic Ordering Number	Flow Coefficient (Cv)	Dimensions	
			L	F
			in. (mm)	in.
1/4	-QTM2-NS4-S	0.2	1.91 (48.5)	5/8
1/4	-QTM4-NS4-S	1.4	2.46 (62.5)	15/16
3/8	-QTM2-NS6-S	0.7	2.04 (51.8)	3/4
3/8	-QTM4-NS6-S	1.8	2.46 (62.5)	15/16
1/2	-QTM8-NS8-S	5.1	2.78 (70.6)	1 5/16
3/4	-QTM8-NS12-S	8.5	2.78 (70.6)	1 5/16
1	-QTM8-NS16-S	—	3.03 (77.0)	1 3/8

Hoses Quick-Connects

D-52 Quick-Connects

Male BSPT

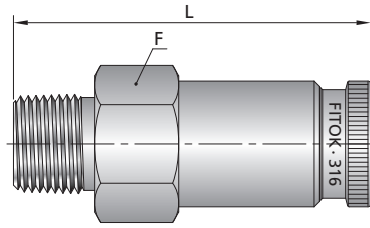

BSPT Size in.	Basic Ordering Number	Flow Coefficient (Cv)	Dimensions	
			L	F
			in. (mm)	in.
1/4	-QTM2-RT4-S	0.2	1.91 (48.5)	5/8
1/4	-QTM4-RT4-S	1.4	2.46 (62.5)	15/16
3/8	-QTM2-RT6-S	0.7	2.04 (51.8)	3/4
3/8	-QTM4-RT6-S	1.8	2.46 (62.5)	15/16
1/2	-QTM8-RT8-S	5.1	2.78 (70.6)	1 5/16
3/4	-QTM8-RT12-S	8.5	2.78 (70.6)	1 5/16
1	-QTM8-RT16-S	—	3.03 (77.0)	1 3/8

Male JIC(AN) 37° Flare

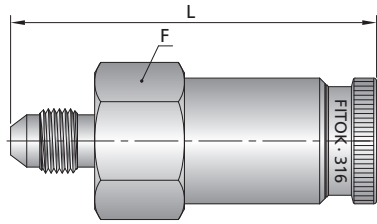

Fitting Size in.	Basic Ordering Number	Flow Coefficient (Cv)	Dimensions	
			L	F
			in. (mm)	in.
1/4	-QTM4-AN4-S	—	2.52 (64.0)	15/16
1/2	-QTM8-AN8-S	4.2	2.46 (70.6)	1 5/16

Bulkhead Tube Fitting

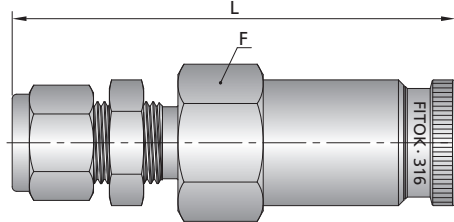

Fitting Size in.	Basic Ordering Number	Flow Coefficient (Cv)	Dimensions		Min. Panel Orifice	Max. Panel Thickness
			L	F		
			in. (mm)	in.		
1/4	-QTM4-BFL4-S	0.9	3.05 (77.5)	15/16	0.46 (11.7)	0.15 (3.8)
3/8	-QTM4-BFL6-S	1.7	3.05 (77.5)	15/16	0.58 (14.7)	0.15 (3.8)
1/2	-QTM8-BFL8-S	4.2	3.54 (89.9)	1 5/16	0.77 (19.6)	0.19 (4.8)
mm	—	—	mm (in.)	mm	mm (in.)	mm (in.)
6	-QTM4-BML6-S	0.9	77.5 (3.05)	24	11.7 (0.46)	3.8 (0.15)
10	-QTM4-BML10-S	1.7	77.7 (3.06)	24	16.8 (0.66)	3.8 (0.15)
12	-QTM8-BML12-S	4.2	89.9 (3.54)	35	19.6 (0.77)	4.8 (0.19)

Bodies

Tube Fitting

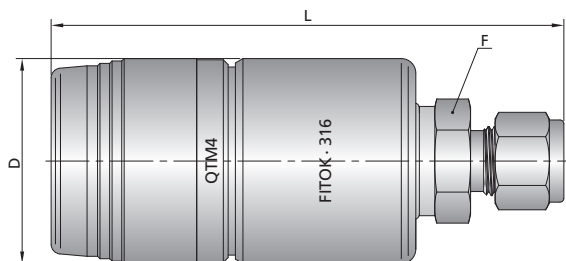

Fitting Size in.	Basic Ordering Number	Dimensions		
		L in. (mm)	D in. (mm)	F in.
1/4	-QTM2-FL4-B	3.16 (80.3)	1.12 (28.4)	9/16
1/4	-QTM4-FL4-B	4.17 (106)	1.68 (42.7)	7/8
3/8	-QTM2-FL6-B	3.25 (82.6)	1.12 (28.4)	3/4
3/8	-QTM4-FL6-B	4.17 (106)	1.68 (42.7)	7/8
1/2	-QTM8-FL8-B	4.30 (109)	2.00 (50.8)	1 1/8
3/4	-QTM8-FL12-B	4.30 (109)	2.00 (50.8)	1 1/8
1	-QTM8-FL16-B	4.58 (116)	2.00 (50.8)	1 3/8
mm	—	—	mm (in.)	mm
6	-QTM2-ML6-B	80.3 (3.16)	28.4 (1.12)	15
6	-QTM4-ML6-B	106 (4.17)	42.7 (1.68)	24
8	-QTM2-ML8-B	80.3 (3.16)	28.4 (1.12)	15
10	-QTM4-ML10-B	106 (4.17)	42.7 (1.68)	24
12	-QTM8-ML12-B	109 (4.30)	50.8 (2.00)	30

Female NPT

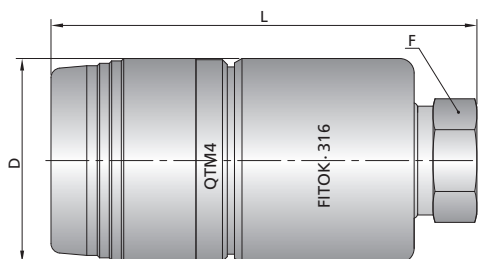

NPT Size in.	Basic Ordering Number	Dimensions		
		L in. (mm)	D in. (mm)	F in.
1/8	-QTM2-FNS2-B	2.60 (66.0)	1.12 (28.4)	9/16
1/4	-QTM2-FNS4-B	2.99 (75.9)	1.12 (28.4)	3/4
1/4	-QTM4-FNS4-B	3.35 (85.1)	1.68 (42.7)	7/8
3/8	-QTM2-FNS6-B	3.04 (77.2)	1.12 (28.4)	7/8
3/8	-QTM4-FNS6-B	3.35 (85.1)	1.68 (42.7)	7/8
1/2	-QTM8-FNS8-B	3.53 (89.7)	2.00 (50.8)	1 1/8
3/4	-QTM8-FNS12-B	4.02 (102)	2.00 (50.8)	1 5/16
1	-QTM8-FNS16-B	4.40 (112)	2.00 (50.8)	1 5/8

Female BSPT

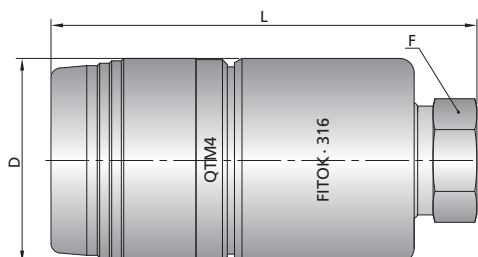

BSPT Size in.	Basic Ordering Number	Dimensions		
		L in. (mm)	D in. (mm)	F in.
1/8	-QTM2-FRT2-B	2.60 (66.0)	1.12 (28.4)	9/16
1/4	-QTM2-FRT4-B	2.99 (75.9)	1.12 (28.4)	3/4
1/4	-QTM4-FRT4-B	3.35 (85.1)	1.68 (42.7)	7/8
3/8	-QTM2-FRT6-B	3.04 (77.2)	1.12 (28.4)	7/8
3/8	-QTM4-FRT6-B	3.35 (85.1)	1.68 (42.7)	7/8
1/2	-QTM8-FRT8-B	3.53 (89.7)	2.00 (50.8)	1 1/8
3/4	-QTM8-FRT12-B	4.02 (102)	2.00 (50.8)	1 5/16
1	-QTM8-FRT16-B	4.40 (112)	2.00 (50.8)	1 5/8

Male NPT

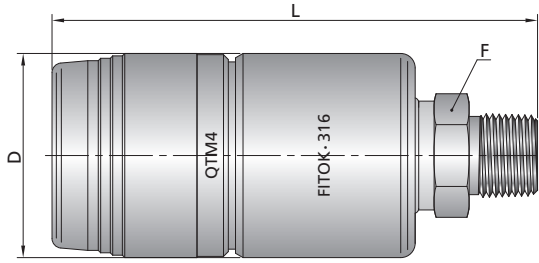

NPT Size in.	Basic Ordering Number	Dimensions		
		L	D	F
		in. (mm)	in. (mm)	in.
1/4	-QTM2-NS4-B	3.02 (76.7)	1.12 (28.4)	9/16
1/4	-QTM4-NS4-B	3.89 (98.8)	1.68 (42.7)	7/8
3/8	-QTM2-NS6-B	3.07 (78.0)	1.12 (28.4)	3/4
3/8	-QTM4-NS6-B	3.97 (100.8)	1.68 (42.7)	7/8
1/2	-QTM8-NS8-B	4.20 (107)	2.00 (50.8)	1 1/8
3/4	-QTM8-NS12-B	4.19 (106)	2.00 (50.8)	1 1/8
1	-QTM8-NS16-B	4.48 (114)	2.00 (50.8)	1 3/8

Male BSPT

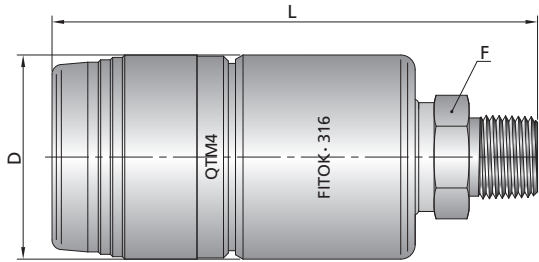

BSPT Size in.	Basic Ordering Number	Dimensions		
		L	D	F
		in. (mm)	in. (mm)	in.
1/4	-QTM2-RT4-B	3.02 (76.7)	1.12 (28.4)	9/16
1/4	-QTM4-RT4-B	3.89 (98.8)	1.68 (42.7)	7/8
3/8	-QTM2-RT6-B	3.07 (78.0)	1.12 (28.4)	3/4
3/8	-QTM4-RT6-B	3.97 (100.8)	1.68 (42.7)	7/8
1/2	-QTM8-RT8-B	4.20 (107)	2.00 (50.8)	1 1/8
3/4	-QTM8-RT12-B	4.19 (106)	2.00 (50.8)	1 1/8
1	-QTM8-RT16-B	4.48 (114)	2.00 (50.8)	1 3/8

Male JIC (AN) 37° Flare

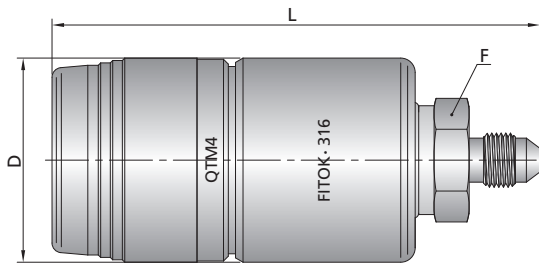

Fitting Size in.	Basic Ordering Number	Dimensions		
		L	D	F
		in. (mm)	in. (mm)	in.
1/4	-QTM4-AN4-B	3.89 (98.8)	1.68 (42.7)	7/8
1/2	-QTM8-AN8-B	4.20 (107)	2.00 (50.8)	1 1/8

Bulkhead Bodies

Bulkhead Tube Fitting

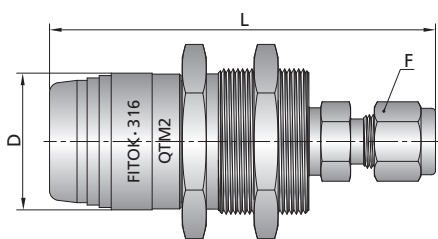
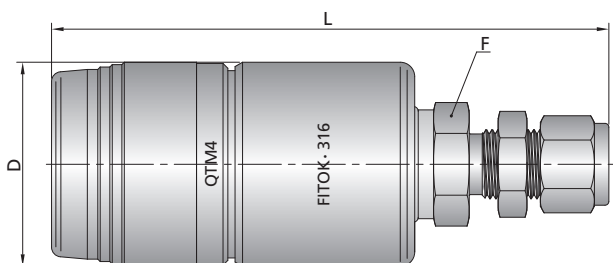

QTM2 Integral Bulkhead

Fitting Size in.	Basic Ordering Number	Dimensions			Min. Panel Orifice in. (mm)	Max. Panel Thickness in. (mm)
		L in. (mm)	D in. (mm)	F in.		
1/4	-QTM2-BFL4-B	3.16 (80.3)	1.12 (28.4)	9/16	1.20 (30.6)	0.65 (16.5)
1/4	-QTM4-BFL4-B	4.42 (112)	1.68 (42.7)	7/8	0.46 (11.7)	0.15 (3.8)
3/8	-QTM4-BFL6-B	4.51 (115)	1.68 (42.7)	7/8	0.58 (14.7)	0.15 (3.8)
1/2	-QTM8-BFL8-B	4.78 (121)	2.00 (50.8)	1 1/8	0.77 (19.6)	0.19 (4.8)
mm		mm (in.)	mm (in.)	mm	mm (in.)	mm (in.)
6	-QTM2-BML6-B	80.3 (3.16)	28.4 (1.12)	15	30.6 (1.20)	16.5 (0.65)
6	-QTM4-BML6-B	112 (4.42)	42.7 (1.68)	24	11.7 (0.46)	3.8 (0.15)
10	-QTM4-BML10-B	115 (4.52)	42.7 (1.68)	24	16.8 (0.66)	3.8 (0.15)
12	-QTM8-BML12-B	121 (4.77)	50.8 (2.00)	30	19.6 (0.77)	4.8 (0.19)

Bulkhead Male NPT

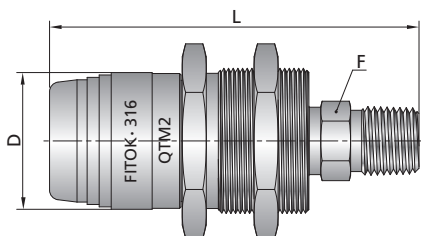

BSPT Size in.	Basic Ordering Number	Dimensions			Min. Panel Orifice in. (mm)	Max. Panel Thickness in. (mm)
		L in. (mm)	D in. (mm)	F in.		
1/4	-QTM2-BNS4-B	3.02 (76.7)	1.12 (28.4)	9/16	1.20 (30.6)	0.65 (16.5)

Bulkhead Male BSPT

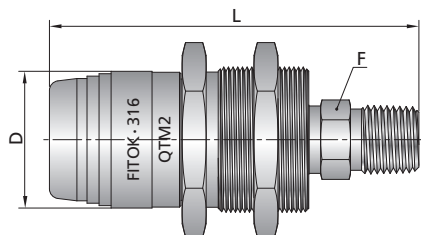

NPT Size in.	Basic Ordering Number	Dimensions			Min. Panel Orifice in. (mm)	Max. Panel Thickness in. (mm)
		L in. (mm)	D in. (mm)	F in.		
1/4	-QTM2-BRT4-B	3.02 (76.7)	1.12 (28.4)	9/16	1.20 (30.6)	0.65 (16.5)

Bulkhead Female NPT

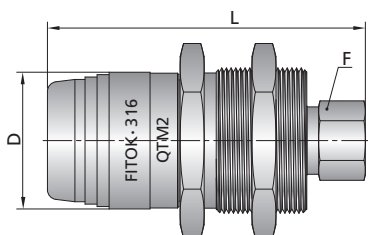

NPT Size in.	Basic Ordering Number	Dimensions			Min. Panel Orifice in. (mm)	Max. Panel Thickness in. (mm)
		L in. (mm)	D in. (mm)	F in.		
1/8	-QTM2-BFNS2-B	2.60 (66.0)	1.12 (28.4)	9/16	1.20 (30.6)	0.65 (16.5)
1/4	-QTM2-BFNS4-B	2.96 (75.2)	1.12 (28.4)	3/4	1.20 (30.6)	0.65 (16.5)

Hoses
Quick-Connects

Bulkhead Female BSPT

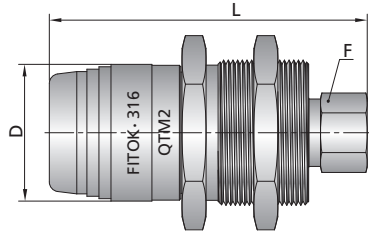

BSPT Size in.	Basic Ordering Number	Dimensions			Min. Panel Orifice in. (mm)	Max. Panel Thickness in. (mm)
		L in. (mm)	D in. (mm)	F in.		
1/8	-QTM2-BFRT2-B	2.60 (66.0)	1.12 (28.4)	9/16	1.20 (30.6)	0.65 (16.5)
1/4	-QTM2-BFRT4-B	2.96 (75.2)	1.12 (28.4)	3/4	1.20 (30.6)	0.65 (16.5)

Options, QTM Series

Keyed QTM Series

FITOK keyed quick-connects feature foolproof mechanical design to prevent accidental mixing of different working lines in actual working conditions.



Features

- ⦿ Keyed quick-connects will not interchange with any other FITOK keyed quick-connects
- ⦿ If an attempt is made to couple unlike keys, the valve system will not open
- ⦿ Stems and bodies are color coded and numbered for easy identification

QTM Series Key Numbers

QTM2 and QTM4 series quick-connects are available in keys K1 through K8.
 QTM8 series quick-connects are available in keys K1 through K4 only (black, orange, green, or yellow).
 Each key number and the corresponding color are shown in "Ordering Number Description" below.

Ordering Number Description

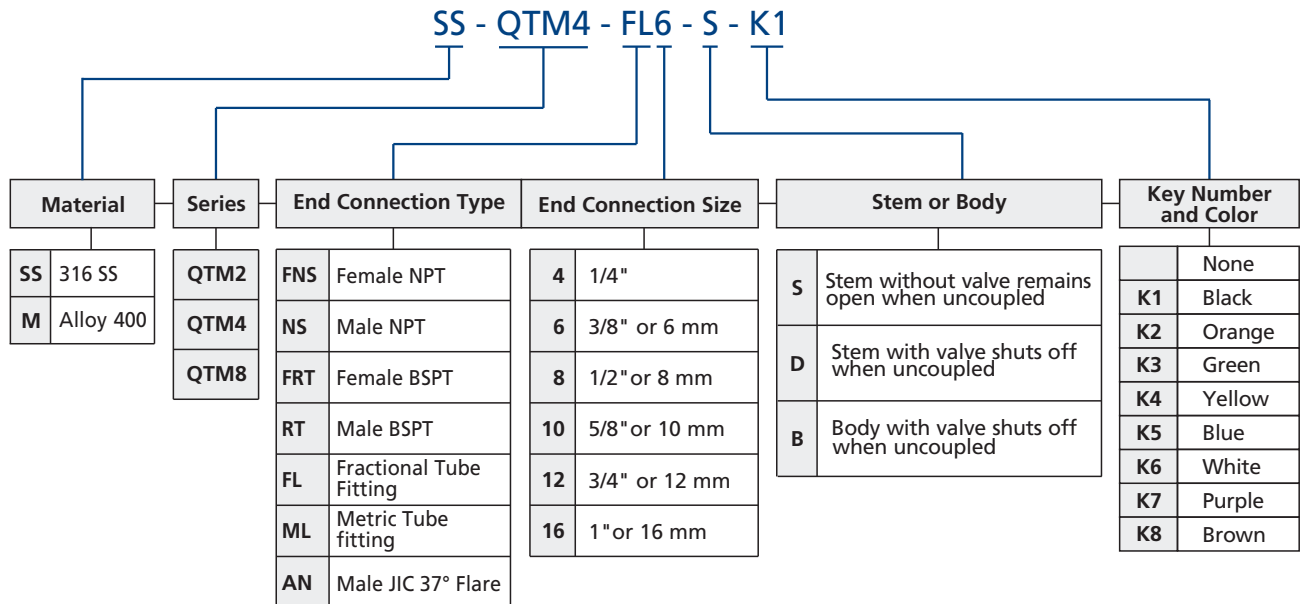

Note: 1. "Ordering Number Description" is a reference to understand the combination rules of FITOK product part number. Not all combinations are available.
 2. Dimensions are for reference only and are subject to change.

info@fitokgroup.com
www.fitokgroup.com

FK-IC-GF-10-EN-220607