

Hoses and Connectors

MH, MM, PS, MP, TH and HC Series

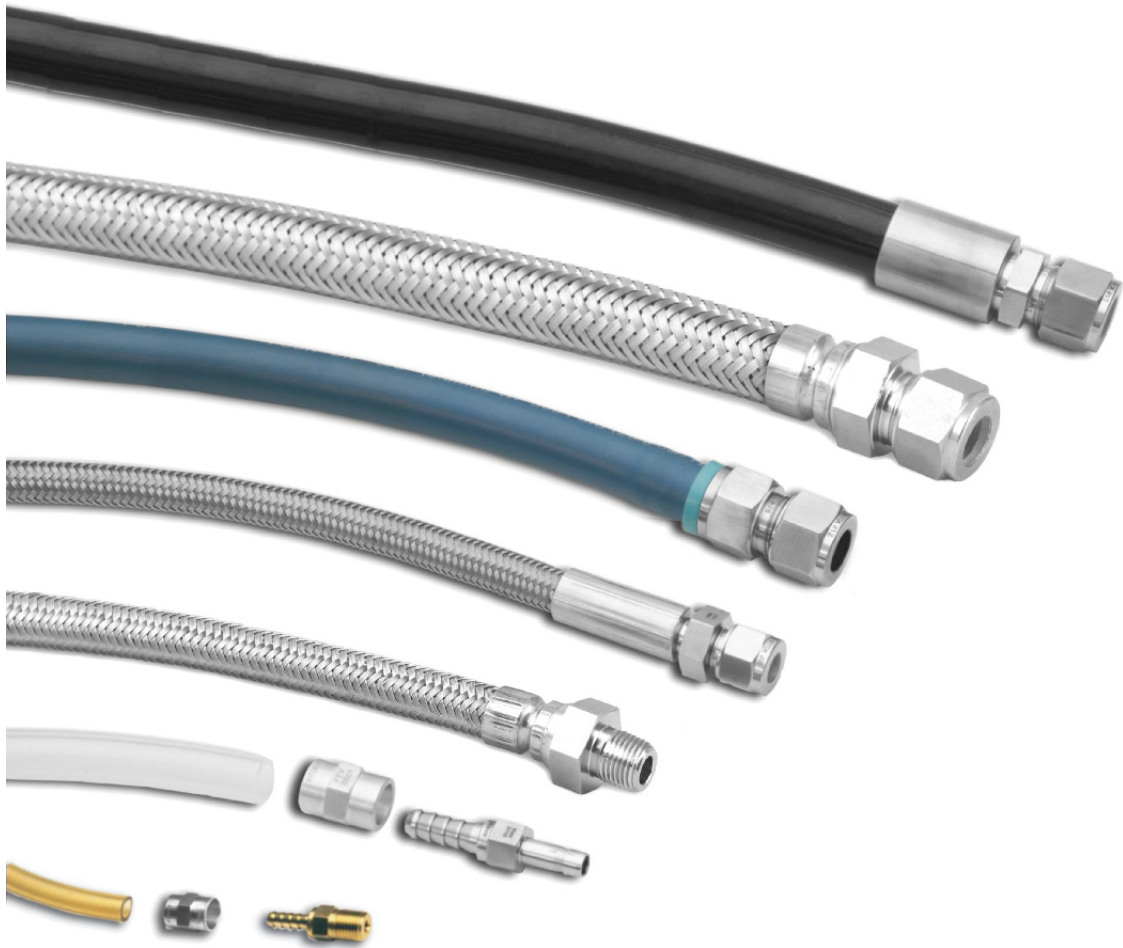

Contents

Terms and Definitions

D-04

Considerations for Selecting a Hose Assembly Solution

D-05

Installation and Use Guide

D-05

Metal Flexible Hoses

MH, MM Series

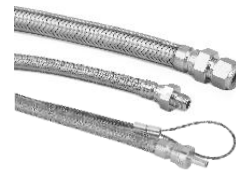

D-07

PTFE-lined, Stainless Steel Braided Hoses

PS Series



D-13

Multipurpose Push-on Hoses

MP Series



D-16

Thermoplastic Hoses

TH Series



D-20

Hose Connectors and Sleeves

HC Series



D-22

Terms and Definitions

Hose

A multiple-layered flexible conduit through which fluid is conveyed from one point to another.

Nominal Hose Size

An approximation of the hose inside diameter.

Bend Radius

The radius of the bent section of a hose, measured to the center line or inside of the curved section.

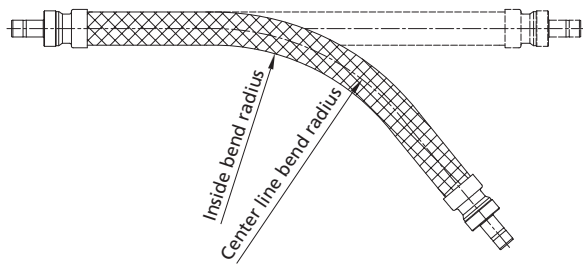

End Connection

The fitting that is assembled onto each end of the hose to provide a means of installation into a fluid system.

Overbraid

A flexible, woven reinforcement.

Maximum Outside Dimension

The largest nominal outside dimension of the hose assembly.

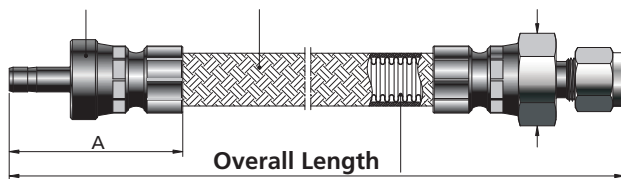

Overall Length

Spring Guard

A helical metal spring used to protect the hose from abrasion overbending, and kinking.

Reinforcement

Material used to reinforce the core and increase its pressure-containing capacity.

Core

The hose's innermost material that comes into contact with the system media, often referred to as the wetted surface.

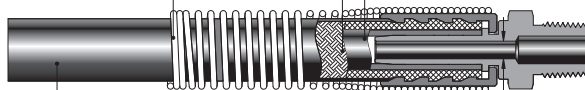

Cover

The hose's outermost material, used to protect the reinforcement and core from environmental conditions and wear.

Minimum Inside Diameter

The smallest inside diameter of inner flow path of the hose assembly.

Minimum Dynamic Bend Radius

The smallest bend radius that a hose is allowed to perform in applications where the hose undergoes dynamic bending and position changes.

Minimum Static Bend Radius

The smallest bend radius that a hose is allowed to perform in applications where the hose is stationary without any movement in any plane.

Flexibility

The relative ease or difficulty of bending a non-pressurized hose assembly.

Burst Pressure

The pressure at which leakage occurs in a laboratory burst test.

Permeation

The movement of a liquid, gas, or vapor through a solid. All materials are permeable to a certain degree and must be tested for application compatibility before installation.

Fire Jacket

Woven fiberglass coated with specially compounded silicone rubber to provide insulation from internal system fluid temperature extremes.

Minimum Inside Diameter

The smallest inside diameter of inner flow path of the hose assembly.

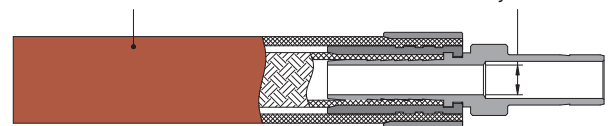

Safety Cable

Prevent hoses from whipping around and causing serious injuries in the event of fitting blow-off or hose burst. The knot at each end of cable can be adjusted before being secured to fixed point.

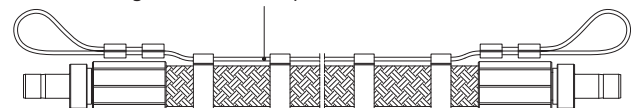

Considerations for Selecting a Hose Assembly Solution

Temperature

Identify the minimum and maximum temperatures the hose assembly will be exposed to in the system media and environment.

Pressure

Identify the minimum and maximum pressures (or vacuum) within and outside the hose assembly.

Material

Identify the system media and the environment that the hose assembly will be exposed to. This will help determine the materials best suited to the application demands.

Movement

Confirm whether the hose assembly will be installed in dynamic applications as this will require different considerations than a static application.

Length

Determine the most likely route for installation of the hose, use this to identify required length.

Note: Different types of hoses vary in measuring position. For hoses with pipe fittings, length loss due to threading into the mating fitting should be taken into account.

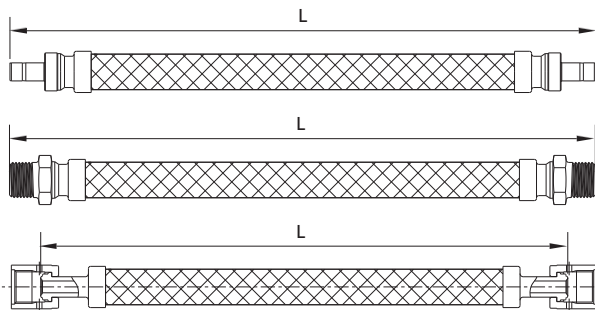

Installation and Use Guide

⚠ Warning

Product failure or improper use may pose a threat to your personal safety and property.

Inspection

Inspect whether the hose length and layout are reasonable, and whether hose surface is free of defects and damage prior to installation. Establish an inspection schedule based on system application and replacement history.

Vibration

Evaluate the amount of system vibration when selecting a hose. Metal hose may not be appropriate for systems with constant or severe vibration.

Cleanliness

Identify the cleanliness need.

End Connection

Identify the type of end connections that are most compatible with the system requirements. End connections differ in materials of construction and pressure ratings.

Orientation

Address space constraint concerns. Hose assemblies with elbows and union ball joints may help resolve space constraint issues.

Desired Flow

Consider desired flow. Hose connection size, core tube construction, and installation route may impact flow.

Additional Protection

Identify whether additional protection is necessary for the hose assemblies or surrounding systems.

Permeability

Nylon, PFA, polyethylene, PTFE, and rubber are permeable materials. Gases and vapors may migrate through cores of these materials. The permeation rate is affected by many factor variables.

Length

Consider hose movement, system pressurization, and thermal expansion when identifying hose length. Installing hose that is not long enough to accommodate these factors may shorten hose life.

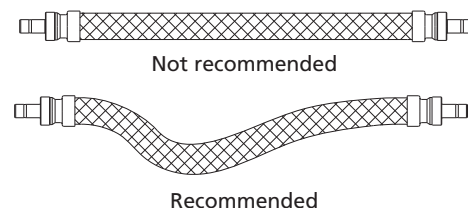

System Pressure Changes

Use sufficient hose length to accommodate system pressure changes. Do not connect high pressure hoses and low pressure hoses together.

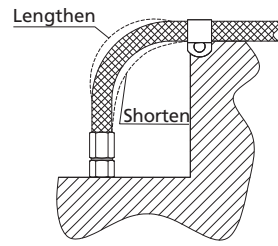

Hose Strain

Elbows and adapters can be used to relieve hose strain.

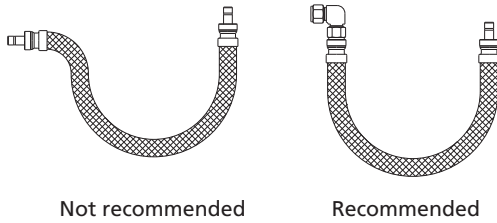

Minimum Bend Radius & Minimum Straight Length

Follow minimum bend radius requirements for your hose. Installing hose with smaller bends may kink hose and shorten hose life.

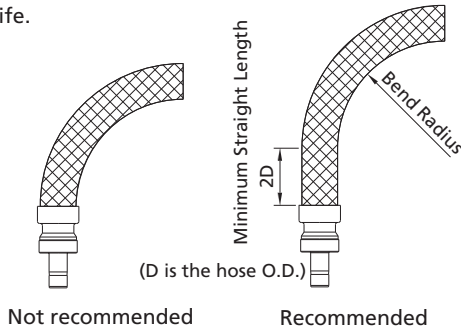

Maintain the minimum straight length for bent section, otherwise, hose rupture or leakage may result from bending too close to the hose/fitting connection.

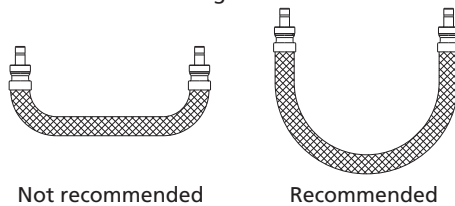

Twist Avoidance

Avoid twisting the hose assembly and causing stress that may affect its use.

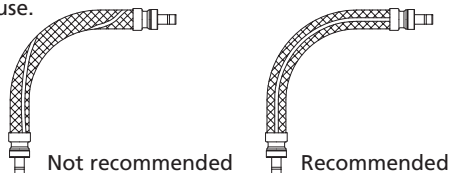

Bending in One Plane

Bend the hose in one plane only so as to avoid twisting. For a compound bend, use multiple hose pieces or other isolation methods.

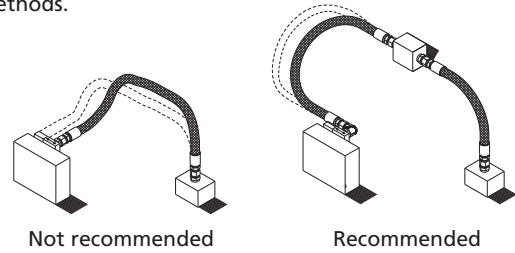

Motion Absorption

Distribute movement and prevent bends smaller than the hose's minimum bend radius by ensuring sufficient hose length.

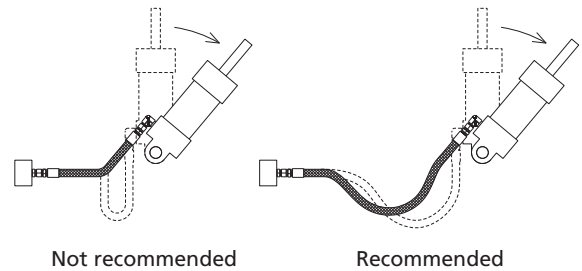

Elbow-connected hoses are better suited for vertical movement than hoses connected with straight fittings.

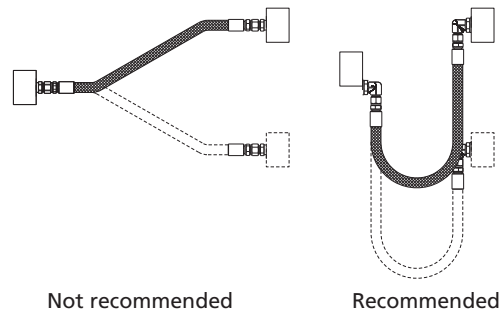

Necessary Limits and Protection Devices

Install necessary limits and protection devices to facilitate hose movement and avoid twisting.

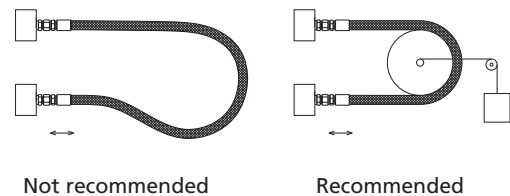

Metal Flexible Hoses

MH, MM Series

Features

- ⦿ Core tube and fitting material: 316, 316L stainless steel
- ⦿ Overbraid material: 304 stainless steel (316 SS available)
- ⦿ Vacuum and positive pressure applications
- ⦿ Working pressure up to: 3100 psig (213 bar)
- ⦿ Nominal hose size: 1/4" to 2"
- ⦿ End connections:
 - 1/4" to 2" pipe thread
 - 1/4" to 2" and 6 mm to 50 mm tube fitting
- ⦿ Working temperature: -325°F to 800°F (-200°C to 426°C)
- ⦿ Welded fitting-to-hose construction to ensure reliable seal
- ⦿ Standard and custom length available

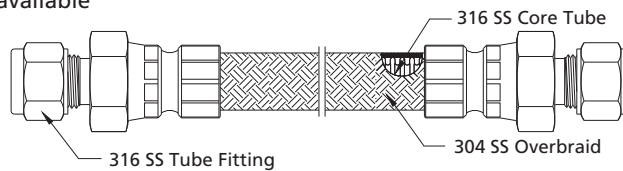

Hose Technical Parameters (MH Series)

Nominal Hose Size	Inside Diameter	Min. Bend Radius		Temperature Range	Working Pressure at 70°F (20°C)	Min. Burst Pressure at 70°F (20°C)
		Static	Dynamic			
in. (mm)	in. (mm)	in. (mm)	in. (mm)	°F (°C)	psig (bar)	psig (bar)
1/4 (6.4)	0.28 (7.1)	2.25 (57.2)	10.0 (254)	-325 to 800 (-200 to 426)	3100 (213)	12400 (854)
3/8 (9.7)	0.42 (10.6)	3.00 (76.2)	12.0 (305)		2000 (137)	8000 (551)
1/2 (12.7)	0.53 (13.5)	4.50 (114)	16.0 (406)		1800 (124)	7200 (496)
3/4 (19.0)	0.80 (20.3)	6.00 (152)	17.0 (432)		1500 (103)	6000 (413)
1 (25.4)	1.03 (26.0)	6.75 (171)	20.0 (508)		1200 (82.6)	4800 (330)
1 1/4 (31.8)	1.30 (33.0)	8.86 (225)	23.0 (584)		950 (65.4)	3800 (261)
1 1/2 (38.1)	1.53 (38.9)	11.0 (280)	26.0 (660)		900 (62.0)	3600 (248)
2 (50.8)	2.05 (52.1)	13.8 (350)	32.0 (813)		500 (34.4)	2000 (137)

Hose Technical Parameters (MM Series)

Nominal Hose Size	Inside Diameter	Min. Bend Radius				Temperature Range	Working Pressure at 70°F (20°C)	Min. Burst Pressure at 70°F (20°C)
		Helical Convoluted Core		Annular Convoluted Core				
		Static	Dynamic	Static	Dynamic			
in. (mm)	in. (mm)	in. (mm)	in. (mm)	in. (mm)	in. (mm)	°F (°C)	psig (bar)	psig (bar)
1/4 (6.4)	0.25 (6.4)	1.38 (35)	8.66 (220)	0.79 (20)	4.33 (110)	-325 to 800 (-200 to 426)	1600 (110)	6400 (440)
3/8 (9.7)	0.38 (9.5)	2.36 (60)	10.40 (264)	0.98 (25)	5.91 (150)		1470 (101)	6000 (413)
1/2 (12.7)	0.50 (12.7)	2.95 (75)	11.89 (302)	1.18 (30)	4.88 (124)		1110 (76.4)	4500 (310)
3/4 (19.0)	0.75 (19.0)	3.54 (90)	13.58 (345)	1.50 (38)	6.65 (169)		860 (59.2)	3500 (241)
1 (25.4)	1.00 (25.4)	4.13 (105)	15.00 (381)	1.77 (45)	7.68 (195)		680 (46.8)	2680 (184)
1 1/4 (31.8)	1.25 (31.8)	4.72 (120)	16.22 (412)	/			680 (46.8)	2600 (179)
1 1/2 (38.1)	1.50 (38.1)	5.51 (140)	16.89 (429)				520 (35.8)	2200 (151)
2 (50.8)	2.00 (50.8)	6.30 (160)	18.43 (468)				450 (31.0)	1800 (124)

Testing

Every FITOK metal flexible hose is factory-tested with nitrogen or air at maximum working pressure and is subject to sampling test with helium to a maximum leak rate of 1×10^{-5} std cm^3/s before shipment. For other requirements, please contact FITOK Group or our authorized distributors.

Cleaning and Packaging

FITOK metal flexible hose components are cleaned in accordance with FITOK *Standard Cleaning and Packaging Process (FC-01)* for general industrial procedures.

Shorter hoses are packed in cartons with suitable protective material, longer hoses are coiled, bagged and boxed or crated.

Pressure vs. Temperature

MH series

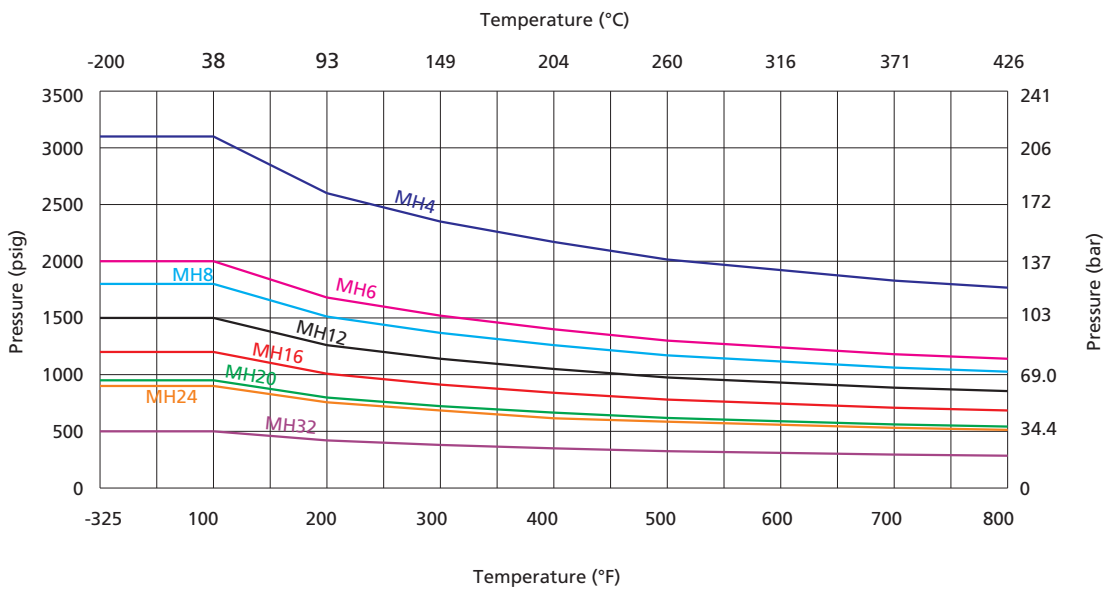

MM series

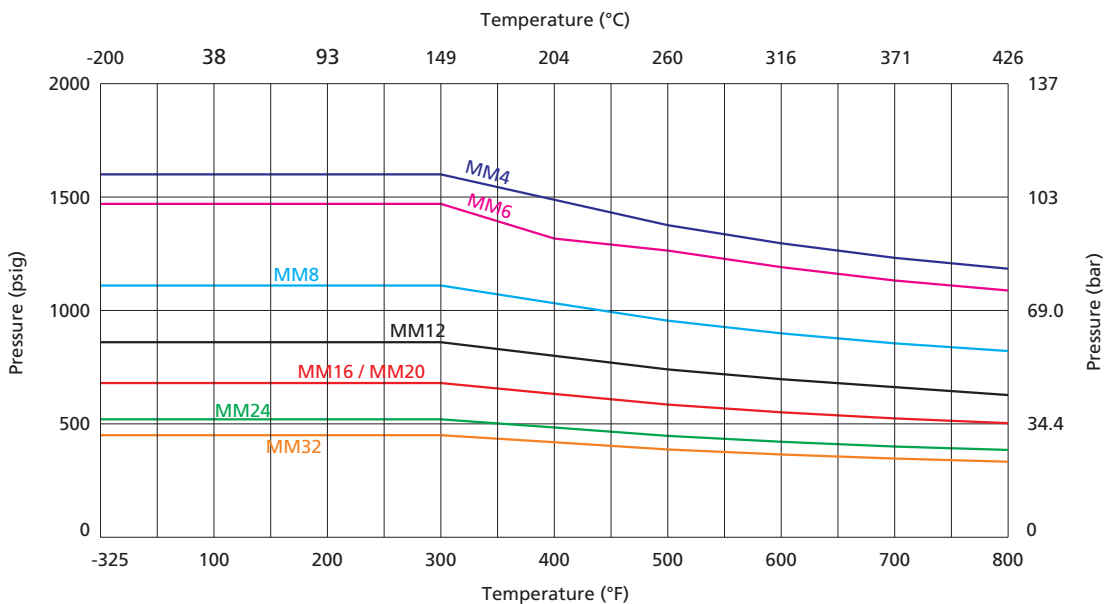

The peak value of pressure surge, shock or pulsations in the system should not exceed 50% of the rated working pressure of the hose.

Standard Assemblies

Tube Fitting to Male NPT End

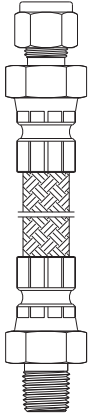

Nominal Hose Size	Tube Fitting Size	NPT Size	Hose Series	Overall Length	Ordering Number	Minimum Inside Diameter	Maximum Outside Dimension
				in. (mm)		in. (mm)	in. (mm)
1/4	1/4	1/4	MH4	12 (305)	SS-MH4-FL4-NS4-F12	0.19 (4.8)	0.94 (23.8)
			MM4	36 (914)	SS-MM4-FL4-NS4-F36	0.19 (4.8)	0.87 (22.0)
3/8	3/8	3/8	MH6	18 (457)	SS-MH6-FL6-NS6-F18	0.28 (7.1)	1.09 (27.7)
			MM6	36 (914)	SS-MM6-FL6-NS6-F36	0.28 (7.1)	1.01 (25.7)
1/2	1/2	1/2	MH8	18 (457)	SS-MH8-FL8-NS8-F18	0.41 (10.4)	1.23 (31.3)
			MM8	48 (1220)	SS-MM8-FL8-NS8-F48	0.41 (10.4)	1.23 (31.3)
3/4	3/4	3/4	MH12	18 (457)	SS-MH12-FL12-NS12-F18	0.66 (16.0)	1.74 (44.2)
			MM12	48 (1220)	SS-MM12-FL12-NS12-F48	0.66 (16.0)	1.59 (40.5)
1	1	1	MH16	24 (610)	SS-MH16-FL16-NS16-F24	0.88 (22.4)	1.82 (46.3)

Tube Fitting End

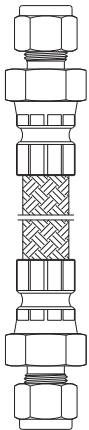

Nominal Hose Size	Tube Fitting Size	Hose Series	Overall Length	Ordering Number	Minimum Inside Diameter	Maximum Outside Dimension
			in. (mm)		in. (mm)	in. (mm)
1/4	1/4	MH4	12 (305)	SS-MH4-FL4-F12	0.19 (4.8)	0.94 (23.8)
		MM4	36 (914)	SS-MM4-FL4-F36	0.19 (4.8)	0.87 (22.0)
3/8	3/8	MH6	18 (457)	SS-MH6-FL6-F18	0.28 (7.1)	1.09 (27.7)
		MM6	36 (914)	SS-MM6-FL6-F36	0.28 (7.1)	1.01 (25.7)
1/2	1/2	MH8	18 (457)	SS-MH8-FL8-F18	0.41 (10.4)	1.23 (31.3)
		MM8	48 (1220)	SS-MM8-FL8-F48	0.41 (10.4)	1.23 (31.3)
3/4	3/4	MH12	18 (457)	SS-MH12-FL12-F18	0.66 (16.0)	1.74 (44.2)
		MM12	48 (1220)	SS-MM12-FL12-F48	0.66 (16.0)	1.59 (40.5)
1	1	MH16	24 (610)	SS-MH16-FL16-F24	0.88 (22.4)	1.82 (46.3)

Tube Adapter End

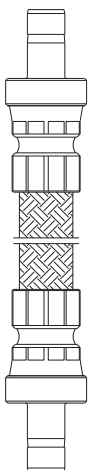

Nominal Hose Size	Tube Adapter Size	Hose Series	Overall Length	Ordering Number	Minimum Inside Diameter	Maximum Outside Dimension
			in. (mm)		in. (mm)	in. (mm)
1/4	1/4	MH4	12 (305)	SS-MH4-FT4-F12	0.16 (4.1)	0.81 (20.6)
		MM4	36 (914)	SS-MM4-FT4-F36	0.16 (4.1)	0.76 (19.2)
3/8	3/8	MH6	12 (305)	SS-MH6-FT6-F12	0.27 (6.9)	1.01 (25.6)
		MM6	36 (914)	SS-MM6-FT6-F36	0.27 (6.9)	0.91 (23.1)

- All dimensions are for reference only and are subject to change. For dimensions not shown above, please contact FITOK Group or our authorized distributors.
- Types listed are standard. Other types are available upon request.

End Connections

Tube Adapters

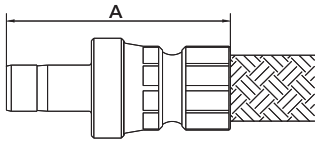

Tube Adapter Size	Nominal Hose Size	End Connection Designator	Dimensions		
			A	Minimum Inside Diameter	Maximum Outside Dimension
in.	in.		in. (mm)		
1/4	1/4	FT4	1.76 (44.7)	0.16 (4.1)	0.81 (20.6)
3/8	3/8	FT6	1.82 (46.2)	0.27 (6.9)	1.01 (25.6)
1/2	1/2	FT8	2.22 (56.4)	0.37 (9.4)	1.23 (31.3)
3/4	3/4	FT12	2.35 (59.7)	0.58 (14.7)	1.53 (38.8)
1	1	FT16	2.69 (68.3)	0.80 (20.3)	1.82 (46.3)
mm	in.	—	mm (in.)		
6	1/4	MT6	44.4 (1.75)	4.1 (0.16)	20.6 (0.81)
10	3/8	MT10	47.0 (1.85)	7.1 (0.28)	25.6 (1.01)
12	1/2	MT12	57.2 (2.25)	8.9 (0.35)	31.3 (1.23)

Tube Fittings

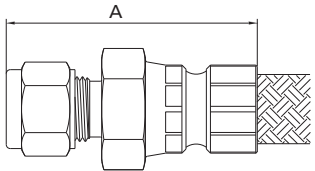

Automatic Weld Style-1 in. and Under

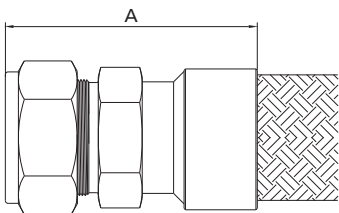

Manual Weld Style-Over 1 in.

Tube Fitting Size	Nominal Hose Size	End Connection Designator	Dimensions		
			A	Minimum Inside Diameter	Maximum Outside Dimension
in.	in.		in. (mm)		
1/4	1/4	FL4	1.94 (49.3)	0.19 (4.8)	0.94 (23.8)
3/8	1/4	FL6	2.00 (50.8)	0.28 (7.1)	0.94 (23.8)
3/8	3/8	FL6	2.02 (51.3)	0.28 (7.1)	1.09 (27.7)
1/2	1/2	FL8	2.24 (56.9)	0.41 (10.4)	1.23 (31.3)
5/8	1/2	FL10	2.27 (57.7)	0.50 (12.7)	1.23 (31.3)
3/4	3/4	FL12	2.35 (59.7)	0.63 (16.0)	1.74 (44.2)
1	1	FL16	2.64 (67.1)	0.88 (22.4)	1.82 (46.3)
1 1/4	1 1/4	FL20	4.04 (103)	1.09 (27.7)	2.23 (58.9)
1 1/2	1 1/2	FL24	4.75 (121)	1.34 (34.0)	2.61 (66.3)
2	2	FL32	5.72 (145)	1.88 (47.8)	3.48 (88.4)
mm	in.	—	mm (in.)		
6	1/4	ML6	62.2 (2.45)	4.8 (0.19)	20.6 (0.81)
8	1/4	ML8	63.2 (2.49)	6.4 (0.25)	20.6 (0.81)
10	3/8	ML10	51.6 (2.03)	7.9 (0.31)	31.3 (1.23)
12	1/2	ML12	56.9 (2.24)	9.7 (0.38)	38.8 (1.53)

Male FR Metal Gasket Face Seal Fittings Swivel

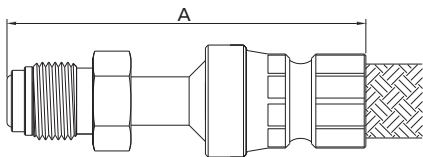

FR Size	Nominal Hose Size	End Connection Designator	Dimensions		
			A	Minimum Inside Diameter	Maximum Outside Dimension
in.	in.		in. (mm)		
1/4	1/4	SFR4	2.60 (66.0)	0.18 (4.6)	0.81 (20.6)
1/2	1/2	SFR8	2.83 (71.9)	0.40 (10.2)	1.23 (31.3)
3/4	3/4	SFR12	4.19 (106)	0.65 (16.5)	1.52 (38.7)
1	1	SFR16	4.80 (122)	0.87 (22.1)	1.53 (38.8)

End Connections

Female FR Metal Gasket Face Seal Fittings Swivel

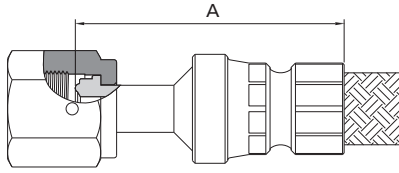

Female FO O-Ring Face Seal Fittings Swivel

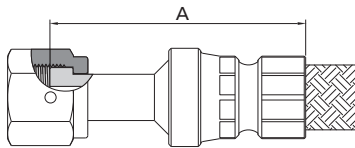

SAE 37° (JIC) Female Swivel

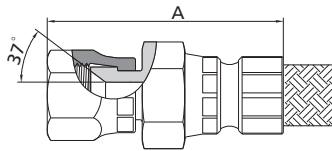

Female Pipe Threads, NPT

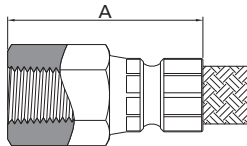

Male Pipe Threads, NPT

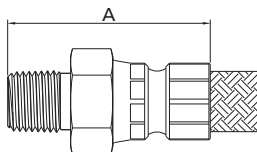

Automatic Weld Style-1 in. and Under

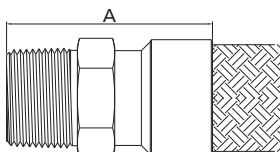

Manual Weld Style-Over 1 in.

FR Size	Nominal Hose Size	End Connection Designator	Dimensions		
			A	Minimum Inside Diameter	Maximum Outside Dimension
in.	in.		in. (mm)		
1/4	1/4	SFFR4	2.00 (50.8)	0.18 (4.6)	0.87 (22.1)
1/2	1/2	SFFR8	2.16 (54.9)	0.40 (10.2)	1.23 (31.3)
3/4	3/4	SFFR12	4.19 (106)	0.65 (16.5)	1.74 (44.2)
1	1	SFFR16	4.80 (122)	0.87 (22.1)	2.03 (51.6)

FO Size	Nominal Hose Size	End Connection Designator	Dimensions		
			A	Minimum Inside Diameter	Maximum Outside Dimension
in.	in.		in. (mm)		
1/4	1/4	SFFO4	2.11 (53.6)	0.18 (4.6)	0.81 (20.6)
1/2	1/2	SFFO8	2.14 (54.4)	0.40 (10.2)	1.23 (31.3)

Swivel Size	Nominal Hose Size	End Connection Designator	Dimensions		
			A	Minimum Inside Diameter	Maximum Outside Dimension
in.	in.		in. (mm)		
1/4	1/4	SAN4	1.87 (47.5)	0.17 (4.3)	0.81 (20.6)
3/8	3/8	SAN6	1.98 (50.3)	0.28 (7.1)	1.01 (25.6)
1/2	1/2	SAN8	2.25 (57.2)	0.42 (10.7)	1.23 (31.3)

NPT Size	Nominal Hose Size	End Connection Designator	Dimensions		
			A	Minimum Inside Diameter	Maximum Outside Dimension
in.	in.		in. (mm)		
1/4	1/4	FNS4	1.81 (46.0)	0.28 (7.1)	0.94 (23.9)
3/8	3/8	FNS6	1.87 (47.5)	0.38 (9.7)	1.09 (27.7)
1/2	1/2	FNS8	2.18 (55.4)	0.47 (11.9)	1.23 (31.3)
3/4	3/4	FNS12	2.21 (56.1)	0.72 (18.3)	1.74 (44.2)

NPT Size	Nominal Hose Size	End Connection Designator	Dimensions		
			A	Minimum Inside Diameter	Maximum Outside Dimension
in.	in.		in. (mm)		
1/4	1/4	NS4	1.80 (45.7)	0.28 (7.1)	0.94 (23.9)
1/4	3/8	NS4	1.81 (46.0)	0.28 (7.1)	1.09 (27.7)
3/8	3/8	NS6	1.81 (46.0)	0.38 (9.7)	1.09 (27.7)
1/2	1/4	NS8	1.99 (50.6)	0.47 (11.9)	1.02 (25.8)
1/2	1/2	NS8	2.15 (54.6)	0.47 (11.9)	1.23 (31.3)
3/4	3/4	NS12	2.22 (56.4)	0.63 (16.0)	1.74 (44.2)
1	1	NS16	2.54 (64.5)	0.88 (22.4)	1.82 (46.3)
1 1/4	1 1/4	NS20	3.06 (77.7)	1.09 (27.7)	2.03 (51.6)
1 1/2	1 1/2	NS24	3.72 (94.5)	1.34 (34.0)	2.47 (62.6)
2	2	NS32	4.19 (106)	1.81 (46.0)	3.19 (81.0)

Options

Anti-whip Cable

- ⊙ 304 stainless steel cable
- ⊙ Available on hoses without changing the technical parameters of hoses
- ⊙ Prevent hoses from whipping around and causing serious injuries in the event of fitting blow-off or hose burst

Ordering Number Description

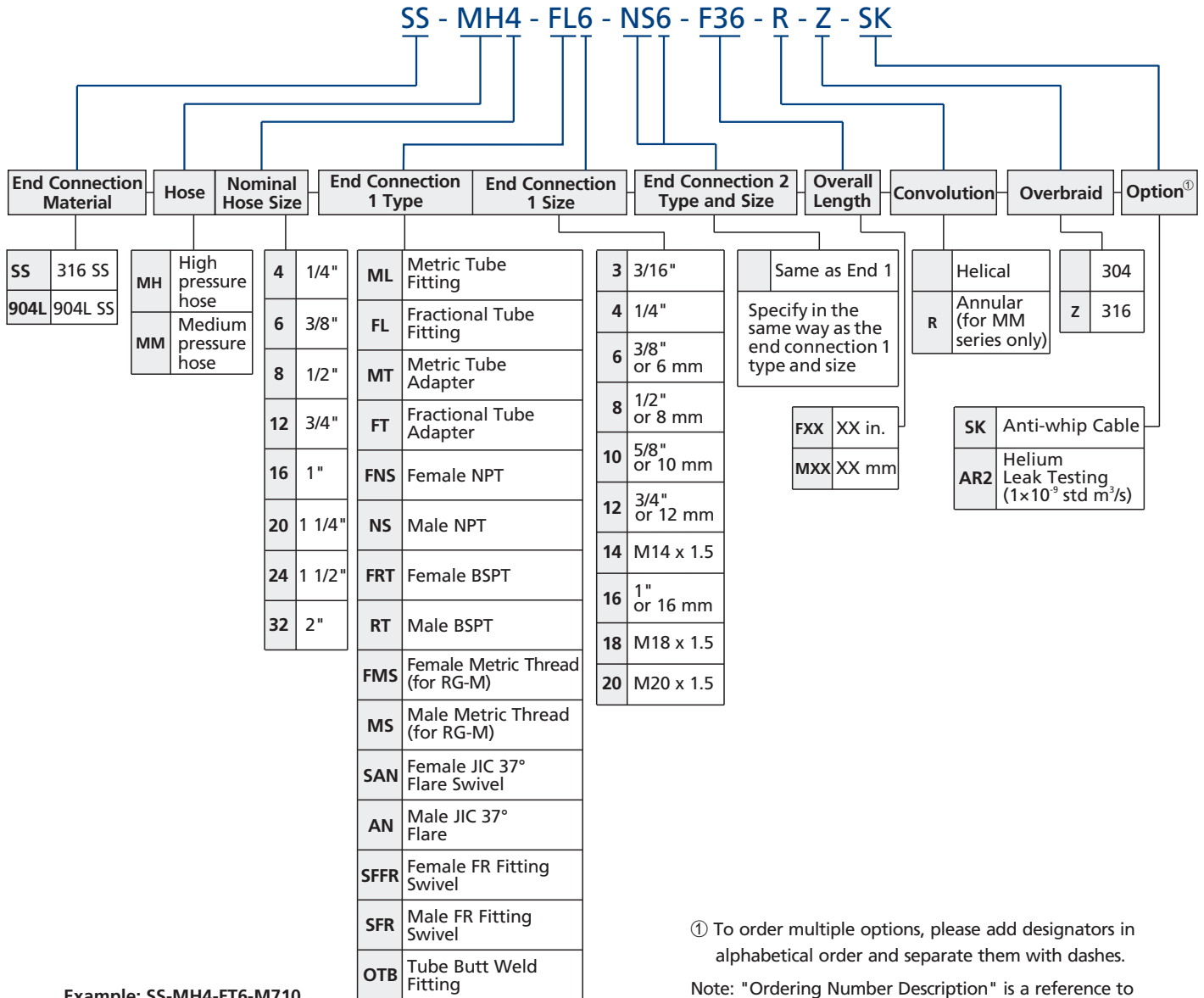

Example: SS-MH4-FT6-M710

SS: End connection material is 316 stainless steel.

MH4: MH series, nominal hose size is 1/4".

FT6: End connection 1 is 3/8" tube adapter.

End connection 2 is 3/8" tube adapter.

M710: Overall length is 710 mm.

Connections are described based on the following rules:

1. Metric Tube Fitting - Fractional Tube Fitting - Metric Tube Adapters - Fractional Tube Adapters - NPT Threads - BSPT Threads - BSPP Threads - SAE/MS Parallel Threads - 37° Flare - FR Fitting - OTB Tube Butt Weld Fitting - Others
2. Put the sizes from the biggest down to the smallest if they are of the same type.
3. Put the female before male if they are of the same type and size.

① To order multiple options, please add designators in alphabetical order and separate them with dashes.

Note: "Ordering Number Description" is a reference to understand the combination rules of FITOK product part number. Not all combinations are available.

PTFE-lined, Stainless Steel Braided Hoses

PS Series

Features

- Lightweight construction for easy handling and installation
- Core tube material: smooth virgin PTFE
- Overbraid material: 304 stainless steel
- Working pressure up to: 3000 psig (207 bar)
- Nominal hose size: 1/8" to 1"
- Working temperature: -65°F to 400°F (-53°C to 204°C)
- Standard and custom length available

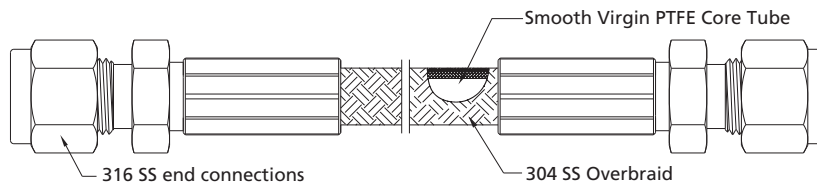
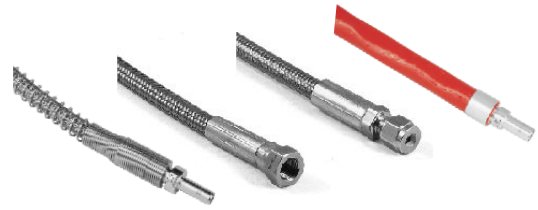

Hose Technical Parameters

Nominal Hose Size	Inside Diameter	Min. Inside Bend Radius		Temperature Range	Working Pressure at 70°F (20°C)	Min. Burst Pressure at 70°F (20°C)
		Static	Dynamic			
in. (mm)	in. (mm)	in. (mm)	in. (mm)	°F (°C)	psig (bar)	psig (bar)
1/8 (3.2)	0.13 (3.2)	1.5 (38.1)	3.75 (95.2)	-65 to 400 (-53 to 204)	3000 (206)	12000 (826)
1/4 (6.4)	0.19 (4.8)	1.5 (38.1)	2.0 (50.8)		3000 (206)	12000 (826)
3/8 (9.5)	0.31 (7.9)	3.5 (88.9)	5.0 (127)		2500 (172)	10000 (690)
1/2 (12.7)	0.41 (10.3)	4.5 (114)	6.0 (152)		2000 (137)	8000 (551)
3/4 (19.0)	0.63 (15.9)	6.0 (152)	7.5 (190)		1500 (103)	6000 (413)
1 (25.4)	0.88 (22.2)	9.0 (229)	11.3 (287)		1000 (68)	4000 (275)

Pressure vs. Temperature

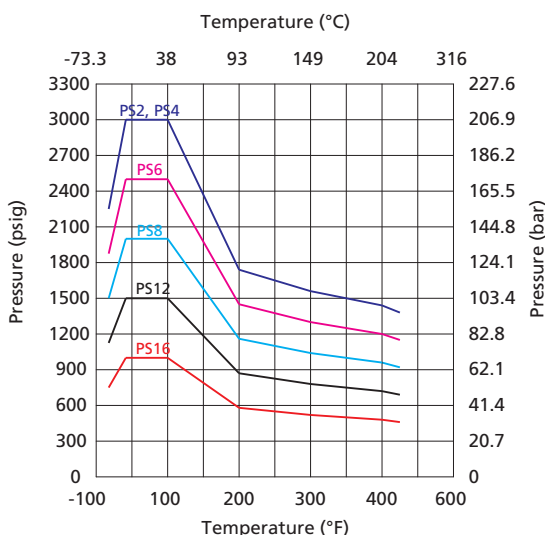

Testing

Every FITOK PTFE-lined hose assembly is factory tested with pure water at 1.5 times the maximum working pressure.

Cleaning and Packaging

FITOK PTFE-lined hose components are cleaned in accordance with FITOK *Standard Cleaning and Packaging Process (FC-01)* for general industrial procedures.

Shorter hoses are packed in cartons with suitable protective material, longer hoses are coiled, bagged and boxed or crated.

PTFE-lined Hose Standard Assemblies

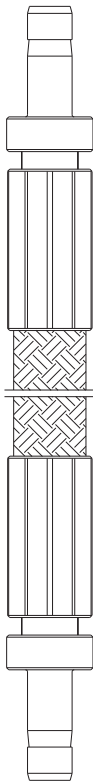

1. All dimensions are for reference only and are subject to change. For dimensions not shown above, please contact FITOK Group or our authorized distributors.
2. Sizes and types listed are standard. Other sizes and types are available on request.

Nominal Hose Size	Tube Adapter Size	Overall Length	Ordering Number	Minimum Inside Diameter	Maximum Outside Dimension
in.	in.	in. (mm)		in. (mm)	in. (mm)
1/8	1/8	6.0 (153)	SS-PS2-FT2-F6	0.08 (2.0)	0.46 (11.6)
		12.0 (305)	SS-PS2-FT2-F12		
		18.0 (458)	SS-PS2-FT2-F18		
		24.0 (610)	SS-PS2-FT2-F24		
		36.0 (915)	SS-PS2-FT2-F36		
1/4	1/4	6.0 (153)	SS-PS4-FT4-F6	0.16 (4.1)	0.54 (13.7)
		12.0 (305)	SS-PS4-FT4-F12		
		18.0 (458)	SS-PS4-FT4-F18		
		24.0 (610)	SS-PS4-FT4-F24		
		36.0 (915)	SS-PS4-FT4-F36		
		48.0 (1220)	SS-PS4-FT4-F48		
		60.0 (1530)	SS-PS4-FT4-F60		
		72.0 (1829)	SS-PS4-FT4-F72		
120.0 (3050)	SS-PS4-FT4-F120				
3/8	3/8	12.0 (305)	SS-PS6-FT6-F12	0.27 (6.9)	0.73 (18.5)
		18.0 (458)	SS-PS6-FT6-F18		
		24.0 (610)	SS-PS6-FT6-F24		
		36.0 (915)	SS-PS6-FT6-F36		
		48.0 (1220)	SS-PS6-FT6-F48		
		60.0 (1530)	SS-PS6-FT6-F60		
		72.0 (1829)	SS-PS6-FT6-F72		
		96.0 (2439)	SS-PS6-FT6-F96		
120.0 (3050)	SS-PS6-FT6-F120				
1/2	1/2	12.0 (305)	SS-PS8-FT8-F12	0.36 (9.1)	0.86 (21.8)
		24.0 (610)	SS-PS8-FT8-F24		
		36.0 (915)	SS-PS8-FT8-F36		
		48.0 (1220)	SS-PS8-FT8-F48		
		60.0 (1530)	SS-PS8-FT8-F60		
3/4	3/4	24.0 (610)	SS-PS12-FT12-F24	0.53 (13.5)	1.04 (26.4)
		36.0 (915)	SS-PS12-FT12-F36		
1	1	36.0 (915)	SS-PS16-FT16-F36	0.80 (20.3)	1.36 (34.5)
		48.0 (1220)	SS-PS16-FT16-F48		
in.	mm	in. (mm)	—	in. (mm)	in. (mm)
1/4	6	12.0 (305)	SS-PS4-MT6-F12	0.16 (4.1)	0.54 (13.7)
		24.0 (610)	SS-PS4-MT6-F24		
		36.0 (915)	SS-PS4-MT6-F36		
1/2	12	24.0 (610)	SS-PS8-MT12-F24	0.33 (8.4)	0.86 (21.8)
		36.0 (915)	SS-PS8-MT12-F36		

Options

Anti-whip Cable

- ⊙ 304 stainless steel cable
- ⊙ Available on hoses without changing the technical parameters of hoses
- ⊙ Prevent hoses from whipping around and causing serious injuries in the event of fitting blow-off or hose burst

Spring Guard

- ⊙ 302 stainless steel material
- ⊙ Available on hoses without changing the technical parameters of hoses
- ⊙ Protect the hose from abrasion, overbending, and kinking

Fire Jacket

- ⊙ Braided fiberglass coated with organic, high-temperature-resistant iron oxide red silicone rubber
- ⊙ Offers excellent flame and fire protection and has good thermal and electrical insulation with resistance to acid & alkali
- ⊙ Operating temperature from -65 to 500°F (-53 to 260°C) with max. short-term exposure temperature to 3002°F (1650°C).

Ordering Number Description

SS - PS4 - FL6 - FT6 - M1000 - Z - SPF2

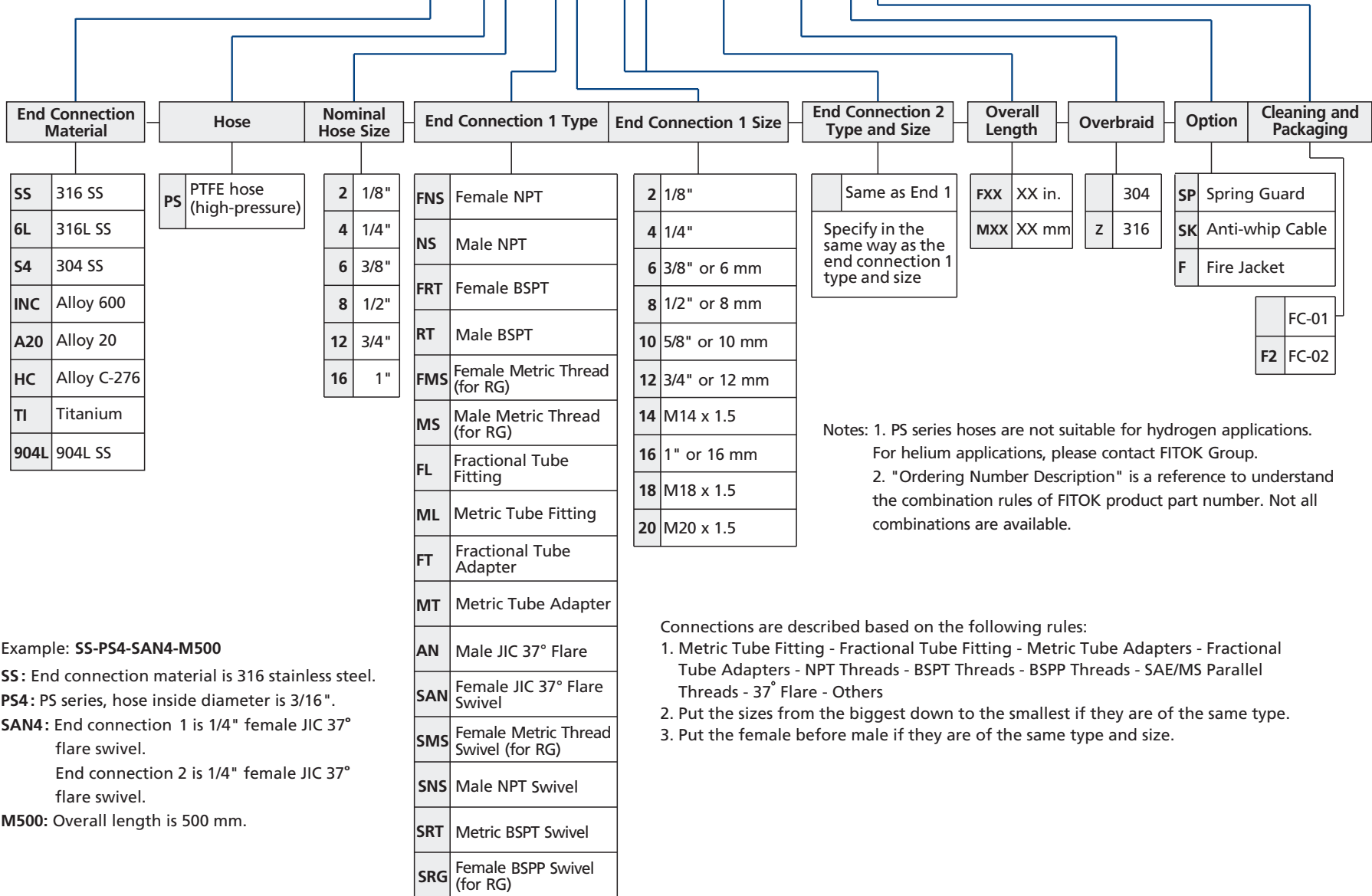

Notes: 1. PS series hoses are not suitable for hydrogen applications. For helium applications, please contact FITOK Group.
 2. "Ordering Number Description" is a reference to understand the combination rules of FITOK product part number. Not all combinations are available.

- Connections are described based on the following rules:
1. Metric Tube Fitting - Fractional Tube Fitting - Metric Tube Adapters - Fractional Tube Adapters - NPT Threads - BSPT Threads - BSPP Threads - SAE/MS Parallel Threads - 37° Flare - Others
 2. Put the sizes from the biggest down to the smallest if they are of the same type.
 3. Put the female before male if they are of the same type and size.

Example: **SS-PS4-SAN4-M500**
SS: End connection material is 316 stainless steel.
PS4: PS series, hose inside diameter is 3/16".
SAN4: End connection 1 is 1/4" female JIC 37° flare swivel.
 End connection 2 is 1/4" female JIC 37° flare swivel.
M500: Overall length is 500 mm.

Multipurpose Push-on Hoses

MP Series

Features

- Cover: weatherproof, abrasion withstanding and oil-resistant synthetic rubber
- Reinforcement: single-braid high-strength synthetic fiber woven for maximum strength and end connection retention
- Core tube: highly oil-resistant rubber
- Hose colors: blue, black, green, gray, red and yellow
- Working pressure up to: 300 psig (20.7 bar)
- Nominal hose size: 1/4" to 3/4"
- Working temperature: -40°F to 200°F (-40°C to 93°C)
- End connection materials: stainless steel and brass
- End connections reusable
- Custom length available

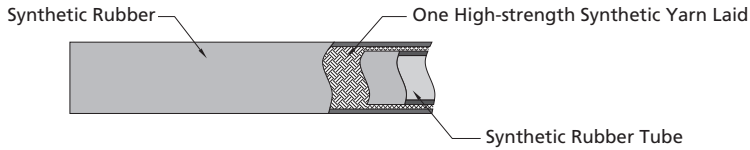

Hose Technical Parameters

Nominal Hose Size	Inside Diameter	Min. Inside Bend Radius	Temperature Range	Working Pressure at -40 to 70°F (-40 to 20°C)	Min. Burst Pressure at 70°F (20°C)
in. (mm)	in. (mm)	in. (mm)	°F (°C)	psig (bar)	psig (bar)
1/4 (6.4)	0.26 (6.6)	2.50 (63.5)	-40 to 200 (-40 to 93)	300 (20.6)	1200 (82.7)
3/8 (9.5)	0.39 (9.9)	3.00 (76.2)			
1/2 (12.7)	0.50 (12.7)	5.00 (127)			
3/4 (19.0)	0.76 (19.3)	7.00 (178)			

Pressure vs. Temperature

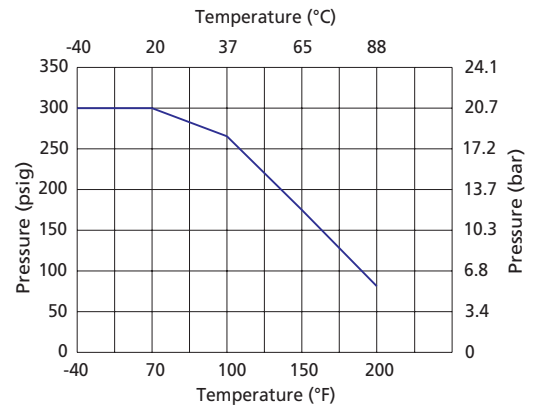

Testing

Every FITOK multipurpose push-on hose assembly is factory tested with pure water at 1.5 times the maximum working pressure.

Cleaning and Packaging

FITOK multipurpose push-on hose components are cleaned in accordance with FITOK *Standard Cleaning and Packaging Process (FC-01)* for general industrial procedures.

Shorter hoses are packed in cartons with suitable protective material, longer hoses are coiled, bagged and boxed or crated.

Caution

- Do not reuse the hose.

Multipurpose Push-on Hose End Connections

Tube Fittings

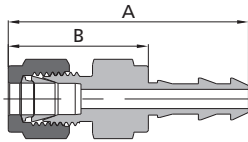

Nominal Hose Size	Tube Fitting Size	Basic Ordering Number	Dimensions, in. (mm)			
			A	B	Minimum Inside Diameter	Maximum Outside Dimension
in.	in.					
1/4	1/4	-MP4-FL4	1.97 (50.0)	1.15 (29.2)	0.16 (4.0)	0.65 (16.5)
3/8	3/8	-MP6-FL6	2.11 (53.6)	1.18 (30.0)	0.27 (6.8)	0.87 (22.0)
1/2	1/2	-MP8-FL8	2.48 (63.0)	1.37 (34.9)	0.37 (9.5)	1.01 (25.7)

Tube Adapters

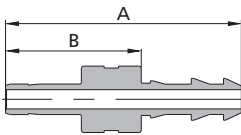

Nominal Hose Size	Tube Adapter Size	Basic Ordering Number	Dimensions, in. (mm)			
			A	B	Minimum Inside Diameter	Maximum Outside Dimension
in.	in.					
1/4	1/4	-MP4-FT4	1.93 (49.0)	1.11 (28.2)	0.16 (4.0)	0.54 (13.8)
3/8	3/8	-MP6-FT6	2.03 (51.6)	1.10 (28.0)	0.27 (6.8)	0.73 (18.5)
1/2	1/2	-MP8-FT8	2.47 (62.7)	1.36 (34.6)	0.37 (9.4)	0.85 (21.5)
3/4	3/4	-MP12-FT12	3.14 (79.8)	1.43 (36.2)	0.58 (14.7)	1.09 (27.7)
in.	mm	—	mm(in.)			
1/4	6	-MP4-MT6	49.0 (1.93)	28.2 (1.11)	4.0 (0.16)	13.8 (0.54)
1/4	8	-MP4-MT8	48.8 (1.92)	28.0 (1.10)	4.0 (0.16)	13.8 (0.54)
3/8	8	-MP6-MT8	52.1 (2.05)	28.5 (1.12)	5.6 (0.22)	18.5 (0.73)
3/8	10	-MP6-MT10	51.6 (2.03)	28.0 (1.10)	6.8 (0.27)	18.5 (0.73)
1/2	12	-MP8-MT12	62.7 (2.47)	34.6 (1.36)	8.8 (0.35)	21.5 (0.85)
3/4	18	-MP12-MT18	79.8 (3.14)	36.2 (1.43)	13.9 (0.55)	27.7 (1.09)

Male NPT Connectors

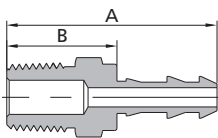

Nominal Hose Size	NPT Tapered Thread Size	Basic Ordering Number	Dimensions, in. (mm)			
			A	B	Minimum Inside Diameter	Maximum Outside Dimension
in.	in.					
1/4	1/4	-MP4-NS4	1.72 (43.7)	0.90 (22.9)	0.16 (4.0)	0.65 (16.5)
3/8	1/4	-MP6-NS4	1.80 (45.7)	0.87 (22.1)	0.27 (6.8)	0.87 (22.0)
3/8	3/8	-MP6-NS6	1.80 (45.7)	0.87 (22.1)	0.27 (6.8)	0.87 (22.0)
1/2	1/2	-MP8-NS8	2.19 (55.6)	1.08 (27.5)	0.37 (9.5)	1.01 (25.7)
3/4	3/4	-MP12-NS12	2.81 (71.4)	1.09 (27.8)	0.61 (15.5)	1.30 (33.0)

Male BSPT Connectors

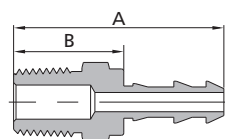

Nominal Hose Size	BSPT Tapered Thread Size	Basic Ordering Number	Dimensions, in. (mm)			
			A	B	Minimum Inside Diameter	Maximum Outside Dimension
in.	in.					
1/4	1/4	-MP4-RT4	1.72 (43.7)	0.90 (22.9)	0.16 (4.0)	0.65 (16.5)
3/8	1/4	-MP6-RT4	1.80 (45.7)	0.87 (22.1)	0.27 (6.8)	0.87 (22.0)
3/8	3/8	-MP6-RT6	1.80 (45.7)	0.87 (22.1)	0.27 (6.8)	0.87 (22.0)
1/2	1/2	-MP8-RT8	2.19 (55.6)	1.08 (27.5)	0.37 (9.5)	1.01 (25.7)
3/4	3/4	-MP12-RT12	2.81 (71.4)	1.09 (27.8)	0.61 (15.5)	1.30 (33.0)

Unions

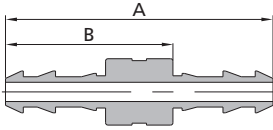

Nominal Hose Size	Basic Ordering Number	Dimensions, in. (mm)			
		A	B	Minimum Inside Diameter	Maximum Outside Dimension
in.					
1/4	-MP4-4	2.19 (55.6)	0.55 (14.0)	0.16 (4.0)	0.54 (13.8)
3/8	-MP6-6	2.38 (60.4)	0.52 (13.2)	0.27 (6.8)	0.73 (18.5)
1/2	-MP8-8	2.75 (69.8)	0.54 (13.6)	0.37 (9.5)	0.85 (21.5)
3/4	-MP12-12	3.96 (100.5)	0.52 (13.3)	0.61 (15.5)	1.09 (27.7)

Hose Ordering Number Description

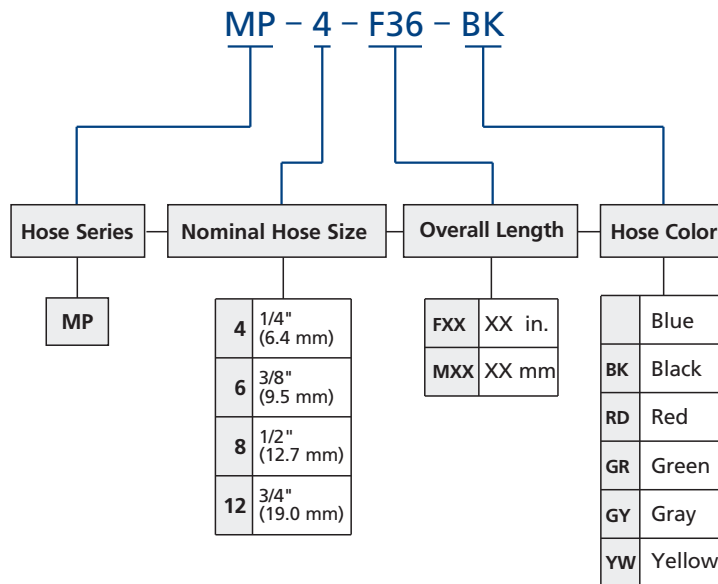
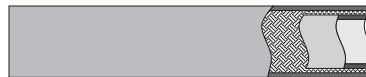

Example: **MP-8-F60-BK**

MP: Hose series

8: Nominal hose size is 1/2".

F60: Overall length is 60".

BK: Hose color is black.

Note: "Ordering Number Description" is a reference to understand the combination rules of FITOK product part number. Not all combinations are available.

Multipurpose Push-On Hose Assemblies

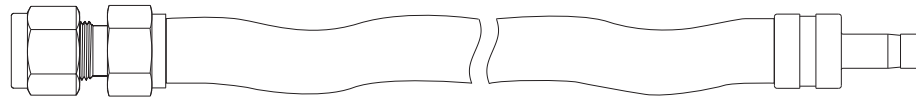

Ordering Number Description

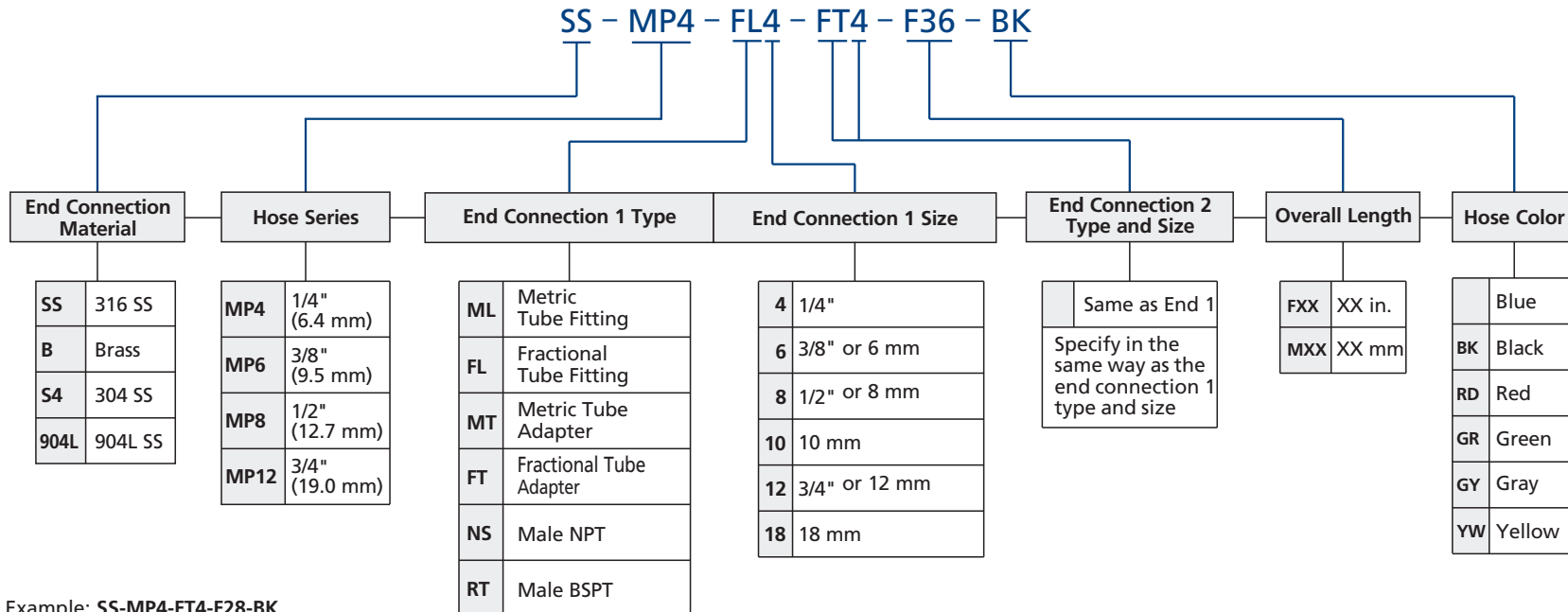

Example: **SS-MP4-FT4-F28-BK**

SS: End connection material is 316 stainless steel.

MP4: MP series, nominal hose size is 1/4" .

FT4: End connection 1 is 1/4" tube adapter.
End connection 2 is 1/4" tube adapter.

F28: Overall length is 28".

BK : Hose color is black.

Connections are described based on the following rules:

1. Metric Tube Fitting - Fractional Tube Fitting - Metric Tube Adapters - Fractional Tube Adapters - NPT Threads - BSPT Threads - BSPP Threads - SAE/MS Parallel Threads - 37° Flare - Others
2. Put the sizes from the biggest down to the smallest if they are of the same type.
3. Put the female before male if they are of the same type and size.

Note: "Ordering Number Description" is a reference to understand the combination rules of FITOK product part number. Not all combinations are available.

Thermoplastic Hoses

TH Series

Features

- ◎ Polyurethane cover: resists oil, weather and abrasion
- ◎ Reinforcement: double-braid high-strength synthetic fiber
- ◎ Core tube: nylon
- ◎ Working pressure up to: 5000 psig (345 bar)
- ◎ Nominal hose size: 3/16" to 1"
- ◎ Working temperature: -40°F to 200°F (-40°C to 93°C)
- ◎ End connections: 1/4 to 1" thread, 1/4" to 1" and 6 mm to 22 mm tube fitting
- ◎ End connection materials: stainless steel
- ◎ Custom length available

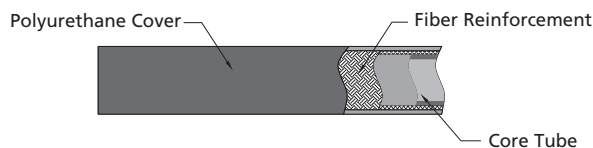

Technical Parameters

Thermoplastic Hydraulic Hose (SAE 100R7)

Nominal Hose Size	Hose Series	Min. Inside Bend Radius	Inside Diameter	Temperature Range	Working Pressure at 70°F (20°C)	Min. Burst Pressure at 70°F (20°C)	Specification
in. (mm)		in. (mm)	in. (mm)	°F (°C)	psig (bar)	psig (bar)	
3/16 (4.8)	TH3	1.58 (40)	0.19 (4.8)	-40 to 200 (-40 to 93)	3000 (207)	12000 (828)	SAE J517 100R7
1/4 (6.4)	TH4	1.97 (50)	0.25 (6.4)		2750 (189)	11000 (758)	
5/16 (8.0)	TH5	2.36 (60)	0.31 (7.9)		2500 (173)	10000 (690)	
3/8 (9.6)	TH6	2.95 (75)	0.38 (9.8)		2250 (155)	9000 (620)	
1/2 (12.7)	TH8	3.74 (95)	0.50 (12.7)		2000 (137)	8000 (551)	

Thermoplastic Hydraulic Hose (SAE 100R8)

Nominal Hose Size	Hose Series	Min. Inside Bend Radius	Inside Diameter	Temperature Range	Working Pressure at 70°F (20°C)	Min. Burst Pressure at 70°F (20°C)	Specification
in. (mm)		in. (mm)	in. (mm)	°F (°C)	psig (bar)	psig (bar)	
3/16 (4.8)	TH3	2.00 (50.8)	0.19 (4.8)	-40 to 200 (-40 to 93)	5000 (344)	20000 (1378)	SAE J517 100R8
1/4 (6.4)	TH4	2.00 (50.8)	0.25 (6.4)		5000 (344)	20000 (1378)	
3/8 (9.6)	TH6	2.50 (63.5)	0.38 (9.8)		4000 (275)	16000 (1102)	
1/2 (12.7)	TH8	4.00 (102)	0.50 (12.7)		3500 (241)	14000 (964)	
3/4 (19.0)	TH12	6.50 (165)	0.75 (19.0)		2250 (155)	9000 (620)	
1 (25.4)	TH16	10.0 (254)	1.00 (25.4)		2000 (137)	8000 (551)	

Testing

Every FITOK thermoplastic hose assembly is factory tested with pure water at 1.5 times the maximum working pressure.

Cleaning and Packaging

FITOK thermoplastic hose components are cleaned in accordance with FITOK *Standard Cleaning and Packaging Process (FC-01)* for general industrial procedures.

Shorter hoses are packed in cartons with suitable protective material, longer hoses are coiled, bagged and boxed or crated.

Options

Anti-whip Cable

- ⦿ 304 stainless steel cable
- ⦿ Available on hoses without changing the technical parameters of hoses
- ⦿ Prevent hoses from whipping around and causing serious injuries in the event of fitting blow-off or hose burst

Thermoplastic Hose Assemblies

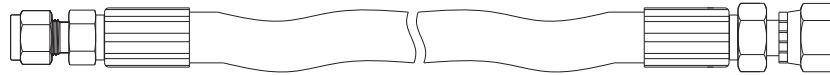

Ordering Number Description

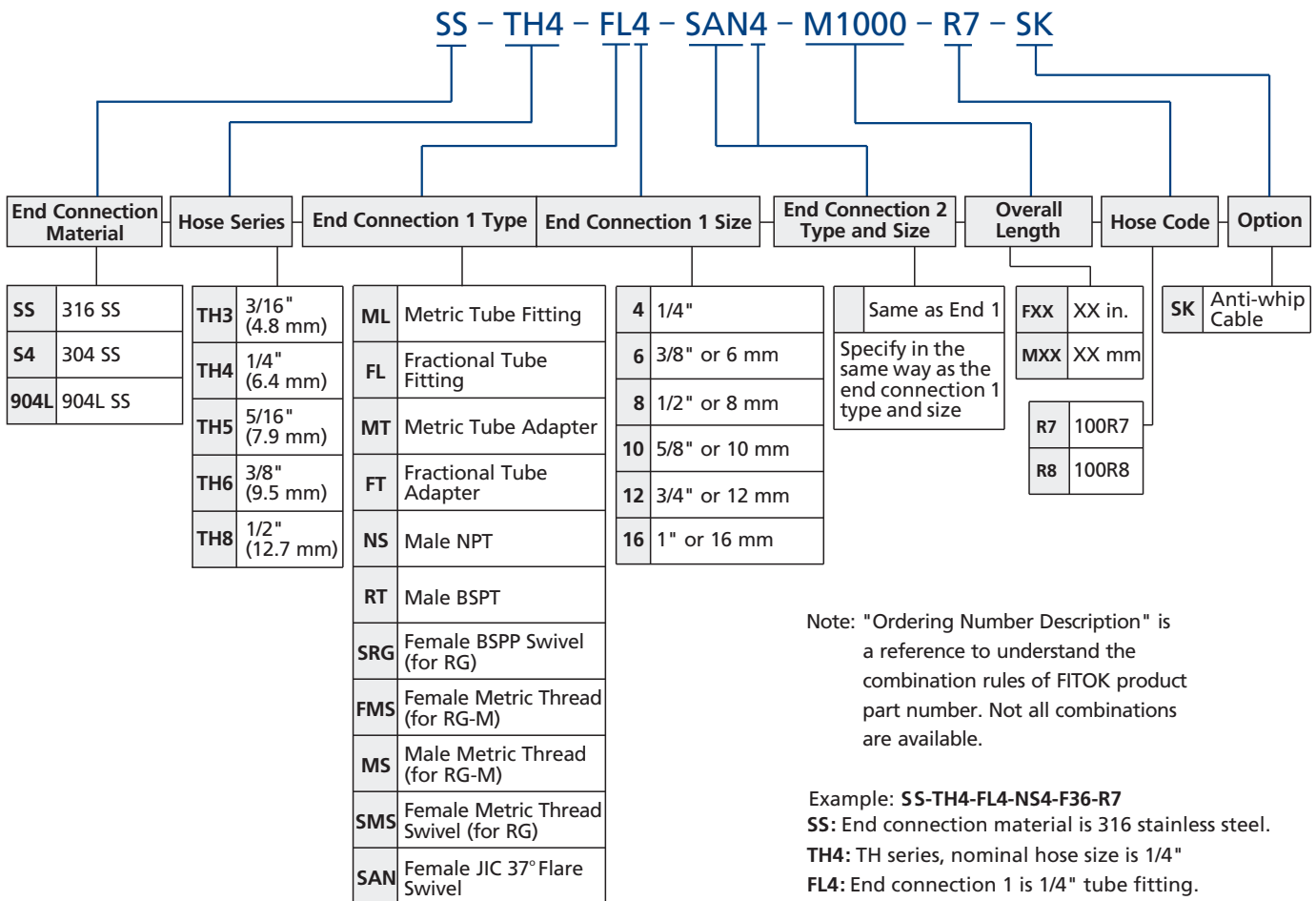

Connections are described based on the following rules:

1. Metric Tube Fitting - Fractional Tube Fitting - Metric Tube Adapters - Fractional Tube Adapters - NPT Threads - BSPT Threads - BSPP Threads - SAE/MS Parallel Threads - 37° Flare - Others
2. Put the sizes from the biggest down to the smallest if they are of the same type.
3. Put the female before male if they are of the same type and size.

Hose Connectors and Sleeves

HC Series

Features

- ⦿ Used to connect soft plastic or rubber tubing
- ⦿ Working pressures and working temperatures are wider than those of the connected hoses
- ⦿ Stainless steel or brass is available
- ⦿ Shank design holds tubing inside diameter securely
- ⦿ Hose connectors are reusable



Hose Connectors

Tube Fittings

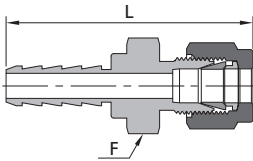

Hose ID	Tube Size	Basic Ordering Number	Dimensions		
			Minimum Inside Diameter	F	L
in.	in.		in. (mm)	in.	in. (mm)
1/8	1/8	-HC-F2-FL2	0.08 (2.0)	7/16	1.42 (36.1)
1/4	1/8	-HC-F4-FL2	0.09 (2.3)	7/16	1.81 (46.0)
	1/4	-HC-F4-FL4	0.19 (4.8)	9/16	1.92 (48.8)
3/8	1/4	-HC-F6-FL4	0.19 (4.8)	9/16	1.99 (50.6)
	3/8	-HC-F6-FL6	0.28 (7.1)	3/4	2.06 (52.3)
1/2	1/2	-HC-F8-FL8	0.38 (9.7)	7/8	2.24 (56.9)
mm	mm	—	mm (in.)	mm	mm (in.)
6	6	-HC-M6-ML6	4.8 (0.19)	14	49.5 (1.95)
8	8	-HC-M8-ML8	6.4 (0.25)	16	49.8 (1.96)
	10	-HC-M8-ML10	6.4 (0.25)	18	51.6 (2.03)
10	10	-HC-M10-ML10	7.9 (0.31)	19	52.3 (2.06)
12	12	-HC-M12-ML12	9.7 (0.38)	22	57.4 (2.26)

Tube Adapters

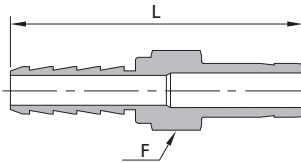

Hose ID	Tube Size	Basic Ordering Number	Dimensions		
			Minimum Inside Diameter	F	L
in.	in.		in. (mm)	in.	in. (mm)
1/8	1/8	-HC-F2-FT2	0.08 (2.0)	5/16	1.37 (34.8)
	1/4	-HC-F2-FT4	0.09 (2.3)	3/8	1.47 (37.3)
1/4	1/4	-HC-F4-FT4	0.19 (4.8)	7/16	1.86 (47.2)
	3/8	-HC-F4-FT6	0.19 (4.8)	7/16	1.92 (48.8)
5/16	1/4	-HC-F5-FT4	0.19 (4.8)	7/16	1.94 (49.3)
3/8	1/4	-HC-F6-FT4	0.19 (4.8)	9/16	1.94 (49.3)
	3/8	-HC-F6-FT6	0.28 (7.1)	9/16	2.00 (50.8)
	1/2	-HC-F6-FT8	0.30 (7.6)	5/8	2.26 (57.4)
1/2	3/8	-HC-F8-FT6	0.28 (7.1)	11/16	2.07 (52.6)
	1/2	-HC-F8-FT8	0.38 (9.7)	11/16	2.33 (59.2)
3/4	3/4	-HC-F12-FT12	0.63 (16.0)	13/16	2.50 (63.5)
1	1	-HC-F16-FT16	0.80 (20.3)	1 3/8	3.03 (77.0)

Male NPT Connectors

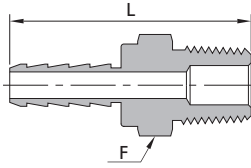

Hose ID	NPT Tapered Thread Size	Basic Ordering Number	Dimensions		
			Minimum Inside Diameter	F	L
in.	in.		in. (mm)	in.	in. (mm)
1/8	1/8	-HC-F2-NS2	0.08 (2.0)	7/16	1.08 (27.4)
	1/4	-HC-F2-NS4	0.08 (2.0)	9/16	1.26 (32.0)
3/16	1/8	-HC-F3-NS2	0.13 (3.3)	7/16	1.27 (32.2)
	1/4	-HC-F3-NS4	0.13 (3.3)	9/16	1.45 (36.8)
1/4	1/8	-HC-F4-NS2	0.19 (4.8)	7/16	1.47 (37.3)
	1/4	-HC-F4-NS4	0.19 (4.8)	9/16	1.65 (41.9)
	3/8	-HC-F4-NS6	0.19 (4.8)	11/16	1.66 (42.2)
	1/2	-HC-F4-NS8	0.19 (4.8)	7/8	1.85 (47.0)
5/16	1/8	-HC-F5-NS2	0.19 (4.8)	7/16	1.55 (39.4)
	1/4	-HC-F5-NS4	0.19 (4.8)	9/16	1.73 (43.9)
	3/8	-HC-F5-NS6	0.19 (4.8)	11/16	1.74 (44.2)
	1/2	-HC-F5-NS8	0.19 (4.8)	7/8	1.96 (49.8)
3/8	1/4	-HC-F6-NS4	0.30 (7.6)	9/16	1.73 (43.9)
	3/8	-HC-F6-NS6	0.30 (7.6)	11/16	1.74 (44.2)
	1/2	-HC-F6-NS8	0.30 (7.6)	7/8	1.96 (49.8)
1/2	1/4	-HC-F8-NS4	0.30 (7.6)	11/16	1.80 (45.7)
	3/8	-HC-F8-NS6	0.38 (9.7)	11/16	1.81 (46.0)
	1/2	-HC-F8-NS8	0.38 (9.7)	7/8	2.03 (51.6)
5/8	3/8	-HC-F10-NS6	0.38 (9.7)	1 1/16	1.88 (47.8)
	1/2	-HC-F10-NS8	0.47 (11.9)	1 1/16	2.07 (52.6)
	3/4	-HC-F10-NS12	0.50 (12.7)	1 1/16	2.07 (52.6)
3/4	1/2	-HC-F12-NS8	0.47 (11.9)	1 1/16	2.14 (54.4)
	3/4	-HC-F12-NS12	0.63 (16.0)	1 1/16	2.14 (54.4)
	1	-HC-F12-NS16	0.63 (16.0)	1 3/8	2.43 (61.7)
1	3/4	-HC-F16-NS12	0.63 (16.0)	1 3/8	2.38 (60.5)
	1	-HC-F16-NS16	0.88 (22.4)	1 3/8	2.57 (65.3)

Female NPT Connectors

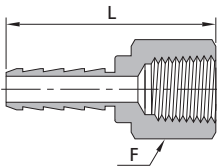

Hose ID	NPT Size	Basic Ordering Number	Dimensions		
			Minimum Inside Diameter	F	L
in.	in.		in. (mm)	in.	in. (mm)
1/8	1/8	-HC-F2-FNS2	0.08 (2.0)	9/16	1.11 (28.2)
	1/4	-HC-F2-FNS4	0.08 (2.0)	3/4	1.26 (32.0)
3/16	1/8	-HC-F3-FNS2	0.13 (3.3)	9/16	1.29 (32.8)
	1/4	-HC-F3-FNS4	0.13 (3.3)	3/4	1.44 (36.6)
1/4	1/8	-HC-F4-FNS2	0.19 (4.8)	9/16	1.47 (37.3)
	1/4	-HC-F4-FNS4	0.19 (4.8)	3/4	1.64 (41.7)
	3/8	-HC-F4-FNS6	0.19 (4.8)	7/8	1.71 (43.4)
5/16	1/4	-HC-F5-FNS4	0.19 (4.8)	3/4	1.73 (43.9)
	3/8	-HC-F5-FNS6	0.19 (4.8)	7/8	1.82 (46.2)
3/8	1/4	-HC-F6-FNS4	0.30 (7.6)	3/4	1.69 (42.9)
	3/8	-HC-F6-FNS6	0.30 (7.6)	7/8	1.78 (45.2)
	1/2	-HC-F6-FNS8	0.30 (7.6)	1 1/16	2.03 (51.6)
1/2	1/2	-HC-F8-FNS8	0.38 (9.7)	1 1/16	2.13 (54.1)

Male BSPT Connectors

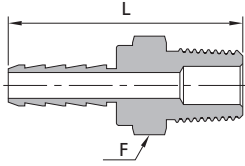

Hose ID	BSPT Tapered Thread Size	Basic Ordering Number	Dimensions		
			Minimum Inside Diameter	F	L
in.	in.		in. (mm)	in.	in. (mm)
1/8	1/8	-HC-F2-RT2	0.08 (2.0)	7/16	1.28 (32.5)
	1/4	-HC-F2-RT4	0.08 (2.0)	9/16	1.40 (35.5)
3/16	1/8	-HC-F3-RT2	0.13 (3.3)	7/16	1.40 (35.5)
	1/4	-HC-F3-RT4	0.13 (3.3)	9/16	1.58 (40.1)
1/4	1/8	-HC-F4-RT2	0.19 (4.8)	7/16	1.47 (37.3)
	1/4	-HC-F4-RT4	0.19 (4.8)	9/16	1.65 (41.9)
	3/8	-HC-F4-RT6	0.19 (4.8)	11/16	1.66 (42.2)
	1/2	-HC-F4-RT8	0.19 (4.8)	7/8	1.90 (48.3)
5/16	1/8	-HC-F5-RT2	0.19 (4.8)	7/16	1.67 (42.4)
	1/4	-HC-F5-RT4	0.19 (4.8)	9/16	1.86 (47.2)
	3/8	-HC-F5-RT6	0.19 (4.8)	11/16	1.87 (47.5)
	1/2	-HC-F5-RT8	0.19 (4.8)	7/8	2.10 (53.3)
3/8	1/4	-HC-F6-RT4	0.30 (7.6)	9/16	1.73 (43.9)
	3/8	-HC-F6-RT6	0.30 (7.6)	11/16	1.74 (44.2)
	1/2	-HC-F6-RT8	0.30 (7.6)	7/8	1.96 (49.8)
1/2	1/4	-HC-F8-RT4	0.30 (7.6)	11/16	1.80 (45.7)
	3/8	-HC-F8-RT6	0.38 (9.7)	11/16	1.81 (46.0)
	1/2	-HC-F8-RT8	0.38 (9.7)	7/8	2.03 (51.6)
5/8	3/8	-HC-F10-RT6	0.38 (9.7)	1 1/16	1.88 (47.8)
	1/2	-HC-F10-RT8	0.47 (11.9)	1 1/16	2.07 (52.6)
	3/4	-HC-F10-RT12	0.50 (12.7)	1 1/16	2.07 (52.6)
3/4	1/2	-HC-F12-RT8	0.47 (11.9)	1 1/16	2.14 (54.4)
	3/4	-HC-F12-RT12	0.63 (16.0)	1 1/16	2.14 (54.4)
	1	-HC-F12-RT16	0.63 (16.0)	1 3/8	2.43 (61.7)
1	3/4	-HC-F16-RT12	0.63 (16.0)	1 3/8	2.38 (60.5)
	1	-HC-F16-RT16	0.88 (22.4)	1 3/8	2.57 (65.3)

Female BSPT Connectors

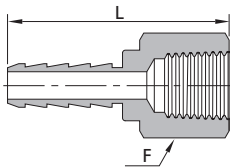

Hose ID	BSPT Size	Basic Ordering Number	Dimensions		
			Minimum Inside Diameter	F	L
in.	in.		in. (mm)	in.	in. (mm)
1/8	1/8	-HC-F2-FRT2	0.08 (2.0)	9/16	1.11 (28.2)
	1/4	-HC-F2-FRT4	0.08 (2.0)	3/4	1.26 (32.0)
3/16	1/8	-HC-F3-FRT2	0.13 (3.3)	9/16	1.29 (32.8)
	1/4	-HC-F3-FRT4	0.13 (3.3)	3/4	1.44 (36.6)
1/4	1/8	-HC-F4-FRT2	0.19 (4.8)	9/16	1.47 (37.3)
	1/4	-HC-F4-FRT4	0.19 (4.8)	3/4	1.64 (41.7)
	3/8	-HC-F4-FRT6	0.19 (4.8)	7/8	1.71 (43.4)
5/16	1/4	-HC-F5-FRT4	0.19 (4.8)	3/4	1.73 (43.9)
	3/8	-HC-F5-FRT6	0.19 (4.8)	7/8	1.82 (46.2)
3/8	1/4	-HC-F6-FRT4	0.30 (7.6)	3/4	1.69 (42.9)
	3/8	-HC-F6-FRT6	0.30 (7.6)	7/8	1.78 (45.2)
	1/2	-HC-F6-FRT8	0.30 (7.6)	1 1/16	2.03 (51.6)
1/2	1/2	-HC-F8-FRT8	0.38 (9.7)	1 1/16	2.13 (54.1)

Metric Thread Connectors

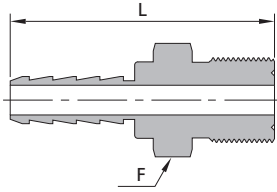

Hose I.D.	Thread Size	Basic Ordering Number	Dimensions		
			Minimum Inside Diameter	F	L
mm	in.		in. (mm)	mm	in. (mm)
6	M10 x 1	-HC-M6-MS10	0.18 (4.6)	12	1.54 (39.6)
	M12 x 1.5	-HC-M6-MS12	0.18 (4.6)	14	1.59 (40.4)
	M14 x 1.5	-HC-M6-MS14	0.18 (4.6)	15	1.66 (42.2)
8	M14 x 1.5	-HC-M8-MS14	0.19 (4.8)	15	1.74 (44.2)
	M16 x 1.5	-HC-M8-MS16	0.19 (4.8)	18	1.82 (46.2)
10	M16 x 1.5	-HC-M10-MS16	0.31 (7.9)	18	1.82 (46.2)
	M18 x 1.5	-HC-M10-MS18	0.31 (7.9)	19	1.86 (47.2)
12	M20 x 1.5	-HC-M12-MS20	0.35 (8.9)	22	1.98 (50.3)
	M22 x 1.5	-HC-M12-MS22	0.35 (8.9)	24	2.08 (52.8)

Hose Connector Sleeves

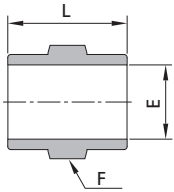

Hose I.D.	Hose O.D.	Ordering Number	Dimensions, in. (mm)		
			E	F	L
in.	in.				
1/8	1/4	AL-HC-F2-F4	0.26 (6.6)	3/8	0.40 (10.2)
1/4	3/8	AL-HC-F4-F6	0.41 (10.4)	9/16	0.79 (20.1)
1/4	7/16	AL-HC-F4-F7	0.46 (11.7)	5/8	0.79 (20.1)
1/4	1/2	AL-HC-F4-F8	0.52 (13.2)	11/16	0.79 (20.1)
5/16	7/16	AL-HC-F5-F7	0.48 (12.2)	5/8	0.87 (22.1)
3/8	1/2	AL-HC-F6-F8	0.55 (14.0)	11/16	0.87 (22.1)
3/8	9/16	AL-HC-F6-F9	0.61 (15.5)	3/4	0.87 (22.1)
7/16	5/8	AL-HC-F7-F10	0.69 (17.5)	13/16	0.94 (23.9)
1/2	11/16	AL-HC-F8-F11	0.76 (19.3)	7/8	0.94 (23.9)
3/4	1	AL-HC-F12-F16	1.10 (27.9)	1 1/4	1.07 (27.2)

- ⦿ Material: Aluminum
- ⦿ Reusable

Hose Clamps

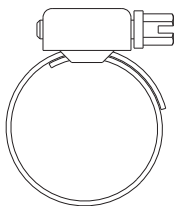

Min. Hose O.D.	Max. Hose O.D.	Ordering Number
mm	mm	
8	12	S4-CP8-12
10	16	S4-CP10-16
12	20	S4-CP12-20
16	25	S4-CP16-25
20	32	S4-CP20-32
25	40	S4-CP25-40

- ⦿ Material: 304 SS
- ⦿ Reusable

1. Sizes and types listed are standard. Other sizes and types are available upon request.
2. All dimensions are for reference only and are subject to change. For dimensions not shown above, please contact FITOK Group or our authorized distributors.

Ordering Number Description

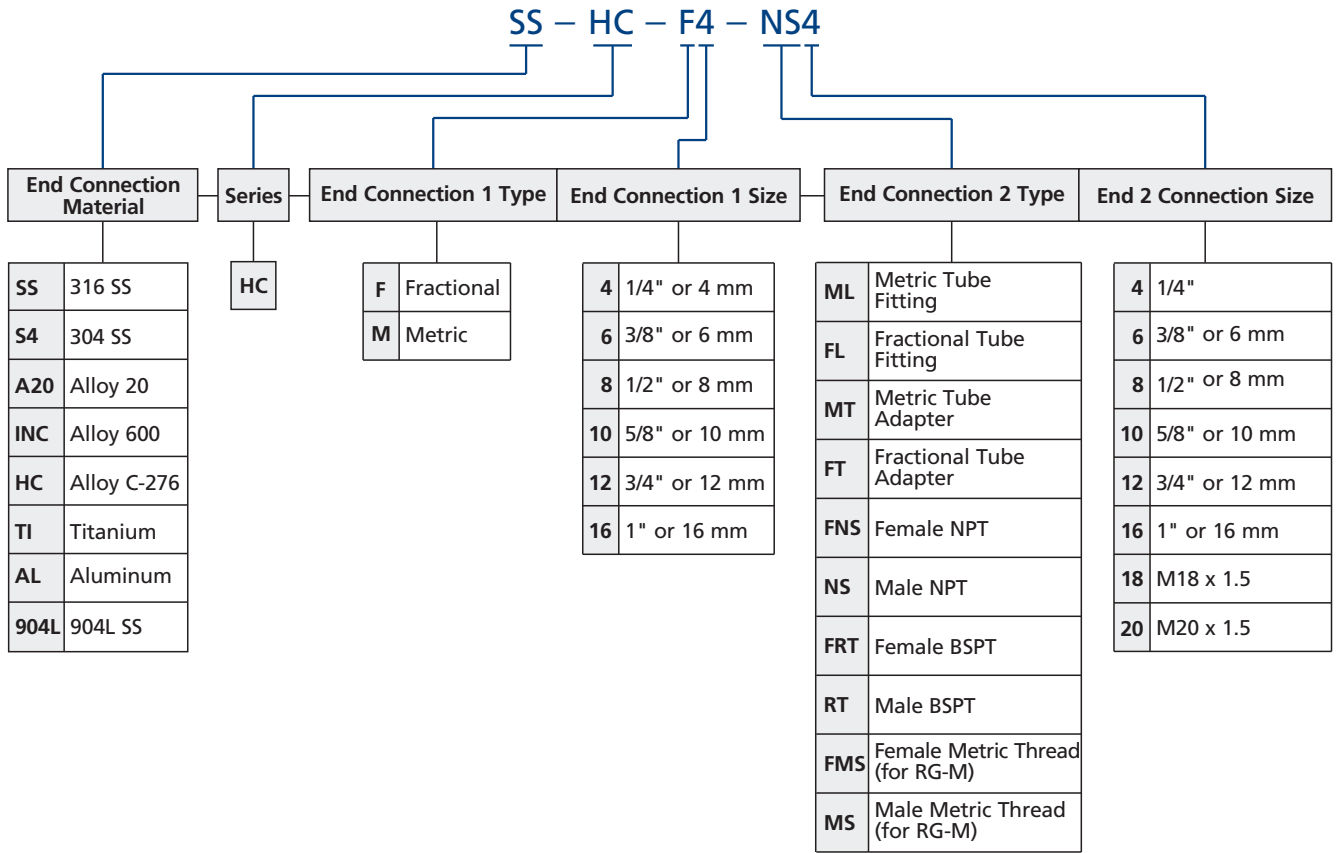

Example: SS-HC-F4-FT6

SS: End connection material is 316 stainless steel.

HC: HC series.

F4: Hose ID is 1/4".

FT6: 3/8" tube adapter.

Note: "Ordering Number Description" is a reference to understand the combination rules of FITOK product part number. Not all combinations are available.